



INTERGLASS



TH

ANNIVERSARY

ESTABLISHED SINCE 2004

www.interglassusa.com



2024

INTERGLASS

Our Purpose: We provide glass fabricators the products needed for success. Since our establishment in 2004, Interglass has been dedicated to the wholesale distribution of glass and mirror products. With a combined footprint of 144,000 sqft of warehouse space and our specialized fleet of trucks which includes Boom Trucks, Rack Trucks and Tractor-trailers. We efficiently perform in-house all of our local logistics needs such as: customs clearance, drayage, warehousing and deliveries. This, combined with our extraordinary employees give us the ability to exceed our customer needs.



Miami, FL



Savannah, GA



Houston, TX







INDEX







- Distribution Regions / Types of Services 4**
- Our Timeline..... 5**
- Float Glass 6**
 - Clear Glass 7
 - Low Iron Glass..... 8
 - Hard Coat Low-E Glass 9
 - Tinted Glass..... 10
 - Patterned Glass 11
 - Satin Acid-Etched Glass 12
 - Black & White Painted Glass 13
- Laminated Glass..... 14**
 - Clear Laminated Glass 15
 - Tinted Laminated Glass 16
 - White Interlayer Laminated Glass 17
- Mirrors 18**
 - Clear Mirror 19
 - Low-Iron Mirror 20
 - Tinted Mirror 21
 - Antique & Satin Mirror 22
 - One-Way Mirror 23
- Glazing Tools..... 24**
 - Glass Fabrication Tools 25
 - Glass & Mirror Installation tools 27
- Swinging Shower Doors 28**
 - Standard Size Shower Doors 29
 - Wall Mount Hinges 30
 - Glass to Glass Hinges..... 32
 - Pivot Hinges..... 34
 - Handles & Towel Bars 36
 - Fixed Panel Clamps 37
 - Glass to Glass Clamps..... 38
 - No Hole Clamps 40
 - U-Channels..... 41
 - Header & Parts 42
 - Seals..... 43
- Sliding Shower Doors 44**
 - Century Sliding System 45
 - Denali Series 46
 - Clearwater Series..... 48
 - NAPA series 50
- Glass Railings 52**
 - Base Shoe Railing..... 53
 - Standoff Railings 56
 - Handrails 57
- Office Partition..... 58**
 - Commercial Pivot Door Parts..... 60
 - Commercial Fixed Panel Parts..... 61
 - Barn Door/ Lacrosse System 62
- Exports 63**

AVAILABLE FINISHES

Brass

Chrome Polished	
Brushed Nickel	
Matte Black	
Brushed Gold	

Aluminum

Brite Anodized	
Brushed Anodized	
Matte Black	
Dark Bronze	
Satin Anodized	
Satin Brass	

Stainless Steel

Polished Stainless.....	
Brushed Stainless.....	
Matte Black	
Satin Brass.....	

DISTRIBUTION REGIONS

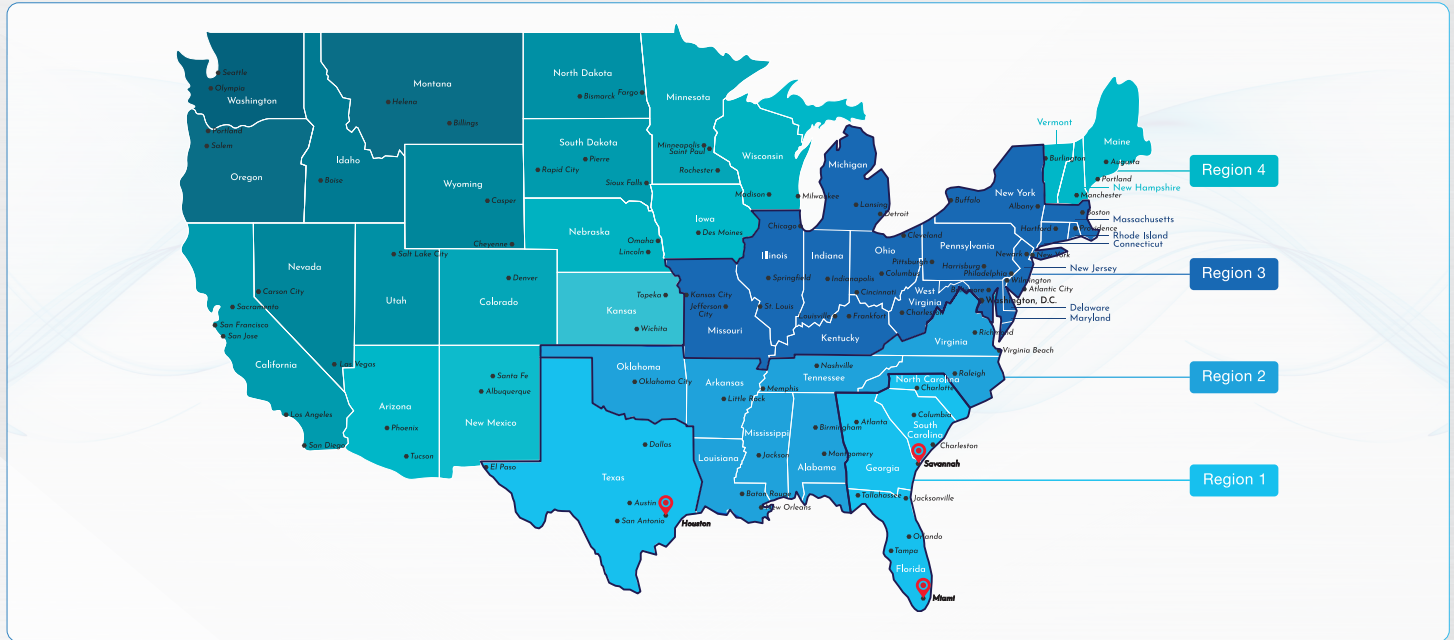

TYPES OF DELIVERY

Boom Truck Delivery Service



- Offered in Region 1 only
- Unloading of Glass & Mirror cases included in service

Tractor-Trailer Delivery Service



- Single drop trailer for easier unloading
- Rolling tarp to protect from rain during transit
- Combine Glass or Mirror cases from our stock
- Competitive price vs float plants

Direct Container Delivery Service

- Directly from the manufacturer to customers warehouse
- Lowest cost service
- Drayage and Customs expenses included, no hidden fees
- Offered in South Florida and some Caribbean islands only



OUR TIMELINE

2004

- Established in March 2004 at 8440 NW 66th Street, Miami, FL



Miami, FL

2007

- Moved to 2175 W 8th Ct. Hialeah, FL with 10,000 sqft



Hialeah, FL

2008

- Acquired the first Boom Truck and hire first CDL driver



2010

- Opened a branch in Tampa, FL
- Introduced Shower Door Hardware product line

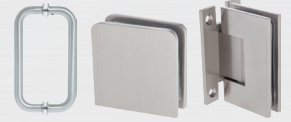

2011

- Moved to 6550 NW 82 Ave, Miami, FL with 26,000 sqft
- Exhibited at GlassBuild Show in Atlanta for the first time



Miami, FL

2015

- Acquired assets of Vetro USA in Medley, FL
- Acquired the first tractor trailer
- Close branch in Tampa, FL



2019

- Introduced Shopify for online ordering
- Moved to 8150 NW 64 St, Miami, FL with 55,000 sqft
- Opened branch in Savannah, GA with 30,000 sqft
- Earned the rank of #4433 on the Inc. 5000 list
- Exhibited at GlassBuild Show in Atlanta



Miami, FL



Savannah, GA



2020

- Introduced Architectural and Railing Hardware
- Sold the custom fabrication division
- Launched iOS & Android Apps
- Started in-house customs clearance

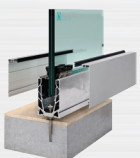

2021

- Exhibited at GlassBuild Show in Atlanta, GA
- Introduced SAMSARA GPS Tracking System
- Started in-house drayage from Port Miami, Port Everglades and Port Savannah

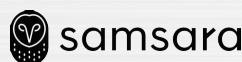

2024

- Celebrating 20 years
- Exhibiting at Glass Expo South East in Orlando, FL
- Exhibiting at MGA Glass Expo in Washington, D.C.
- Exhibiting at Expo North East in New York, NY
- Exhibiting at GlassBuild America in Dallas, TX
- Opening a branch in Houston, TX with 62,000 sqft



Houston, TX



FLOAT GLASS

Meets Standards:

ASTM C1172-14
EN14449
ANSI Z97.1

Visible Light Transmittance (VLT): The percentage of the visible spectrum (light) that is transmitted through the glass.

Exterior Reflectance: The percentage of the visible spectrum (light) that is reflected towards the exterior by the glass.

SHGC: The fraction of incident solar radiation admitted through the glass, both directly transmitted and absorbed and subsequently released inward. SHGC is expressed as a number between 0 and 1. The lower a glass solar heat gain coefficient; the less solar heat it transmits.

Winter U- Value: Measure of the insulating characteristics of the glass in which how much heat gain or loss occurs through the glass due to the difference of indoor and outdoor temperatures using NFRC winter nighttime environmental conditions of a cold outside temperatures and no sunlight.

Interglass cannot be held responsible for any deviation between the data introduced and the conditions on site. Specifications technical and other data are based on information available at the time of preparation of this document and are subject to change without notice. Data values were simulated using Optics 6 & used with Windows 5.2. The performance data is simulated, not actually measured.



Clear Glass

Clear glass is a soda-lime silicate float glass product, intended to be used in residential and commercial applications alike. It's a versatile choice when specialty glass is not needed. It has the standard light green color. It's the type of glass used the most worldwide and the least expensive, and can be used in almost any glass application. Such as double glazing, laminating, tempering, heat-strengthening, bending, coating.

Clear Glass is used on many applications such as: Windows, Doors, etc. As it's an affordable and available product, it's one of the most common and popular choices in the glass industry. Clear glass is commonly used in the industry due to its slight green hue that alters the appearance in some cases, this is due to the iron content present in the glass.

Glass Thickness		Visible Light		UV Transmittance	Solar Heat Gain Coefficient (SHGC)	Winter U-Value English	Winter U-Value Metric W/(M ² x K)	Thickness Tolerances	Dimension Tolerances
mm	inches	Transmittance (VLT)	Exterior Reflectance						
2.3mm	3/32"	90.0%	9.0%	N/A	0.87	1.05	5.94	±0.2mm	±4mm
3mm	1/8"	89.0%	8.6%	73.3%	0.85	1.04	5.90	±0.2mm	±4mm
4mm	5/32"	89.5%	8.6%	71.1%	0.84	1.04	5.88	±0.2mm	±4mm
5mm	3/16"	89.1%	8.5%	68.7%	0.83	1.03	5.86	±0.2mm	±4mm
6mm	1/4"	88.6%	8.5%	66.0%	0.82	1.02	5.82	±0.2mm	±4mm
10mm	3/8"	87.5%	8.3%	57.9%	0.76	1.00	5.69	±0.3mm	±4mm
12mm	1/2"	85.0%	8.0%	N/A	0.73	0.98	5.59	±0.3mm	±4mm
19mm	3/4"	83.0%	8.0%	N/A	0.67	0.95	5.39	±1.0mm	±5mm

Physical and Mechanical Properties	Symbol	Value and unit	Chemical Composition
Density (at 18°C)	ρ	2 500kg/m ³	Silicon Dioxide (69% to 74%)
Knop hardness	Hk0.1/20	6 GPa	Calcium Oxide (5% to 14%)
Young's modulus	E	7x10 ¹⁰ Pa	Sodium Oxide (10% to 16%)
Poisson's ratio	μ	0.2	Magnesium Oxide (0% to 6%)
Specific heat capacity	Cp	0,72 x 103J/(kg.k)	Aluminum Oxide (0% to 3%)
Nominal value of avg coefficient of linear expansion between 20 ° C and 300° C	α	9 x 10-6/K	Other (0% to 5%)
Resistance against temperature differential and sudden temperature change	v40 Kb		
Thermal conductivity	λ	1 W / (m. K)	
Mean refractive index to visible radiation (at 589,3nm)	n	1,5	
Emissivity (corrected)	ϵ	0,837	
Characteristic bending strenght	Fg,kk	45 N/ mm ²	

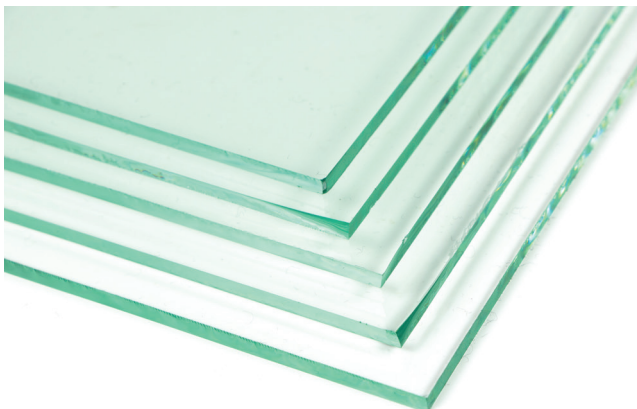

LOW IRON GLASS



Low Iron Glass

Low Iron Glass is an ultra transparent glass with light transmittance more than 91%. It has the characteristics of low spontaneous breakages, high purity, noble elegance and crowned as 'crystal prince' of the glass family.

High transmittance: visible light transmittance near 92%, 6% higher than clear float glass.

High aesthetics: More beautiful than clear float glass, with a jewellike blue edge.

Glass Thickness		Visible Light		Total Penetration	UV Penetration	Shading Coefficient	Winter U-Value Metric W/(M ² x K)
mm	inches	Transmittance (VLT)	Exterior Reflectance				
5mm	3/16"	91.3%	8%	90%	71%	1.03	5.80
6mm	1/4"	91.1%	8%	90%	70%	1.03	5.70
10mm	3/8"	90.6%	8%	89%	66%	1.02	5.60
12mm	1/2"	90.4%	8%	88%	64%	1.01	5.50
19mm	3/4"	89.7%	8%	86%	59%	0.99	5.50

Edge Guide

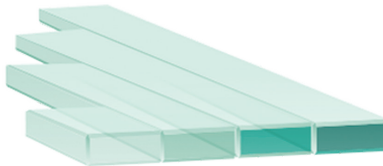

The color of a glass edge depends on the length of glass you are looking through.

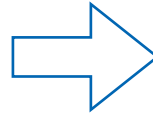

Low-Iron Glass	Regular Clear Glass
Length 12"	Light Green
Length 20"	Medium Green
Length 40"	Dark Green
Length 60"	Black
Length 100"	Black
Length 130"	Black



Benefits of Low-Iron Glass:

1. Elegance
2. Luxury Finish
3. High Quality
4. Undistorted Colors
5. Clarity





Hard Coat Low-E Glass

Low-emissivity glass coatings are designed to increase the reflection of the heat absorbed by the glazing to the interior of the building. In contrast to clear glass, low-emissivity coated glass ensures that heat is retained in a building, enhancing thermal comfort.

Hard coat Low-E Glass is made using a pyrolytic process applied at high temperatures and fired into the glass surface during the float glass manufacturing process. This glass can be heat-treated, laminated, bent, silk screened, and enameled to meet specialized applications. Can be used monolithically, or as part of an insulating glass unit. There is no need for edge deletion when incorporating it in an insulating unit. It's recommended to be installed in surface #4.

Glass Thickness		Visible Light		UV Transmittance	Solar Heat Gain Coefficient (SHGC)	Solar Heat Gain Coefficient (SHGC)	Shading Coefficient (SC)
mm	inches	Transmittance (VLT)	Exterior Reflectance				
3.2mm	1/8"	83%	9.0%	38.9%	0.75	0.75	0.86
5mm	3/16"	82%	6.3%	30%	0.67	1.03	5.86
6mm	1/4"	53%	6.0%	25%	0.63	1.02	5.82



Benefits of Low-E Glass:

1. Energy Efficiency
2. UV Radiation Protection
3. Improved Comfort
4. Daylight and Natural Light
5. Condensation Control

Low-E Glass is a popular choice within people who are choosing an energy-conscious and environmentally friendly alternatives. Best performance is on winter season where the warm temperature in the interior must be kept warm.





Bronze Glass

Bronze Tinted Glass offers solar protection and supports energy efficiency in regions that rely on air conditioning. Provides low levels of light reflection. Can be tempered, laminated, heat-strengthened, insulated. Ideal for use in atriums, skylights, windows, entrances and storefronts. Also in decorative applications such as table tops. This glass is a great option and alternative from traditional clear glass. It allows users to have different possibilities of architectural and decorative applications while at the same keeping the elegance the glass has to offer.

Glass Thickness		Visible Light		UV Transmittance	Solar Heat Gain Coefficient (SHGC)	Winter U-Value English Btu/(Hr x Sqft x °F)	Winter U-Value Metric W/(M ² x K)
mm	inches	Transmittance (VLT)	Exterior Reflectance				
3mm	1/8"	66.8%	6.8%	38.9%	0.73	1.04	5.90
5mm	3/16"	58.5%	6.3%	30.2%	0.67	1.03	5.86
6mm	1/4"	53.2%	6.0%	25.5%	0.63	1.02	5.82
10mm	3/8"	37.7%	5.4%	14.1%	0.52	1.00	5.69
12mm	1/2"	27.0%	5.0%	N/A	0.47	0.98	5.59



Gray Glass

Gray Tinted Glass has a subtle cool light-gray tint which offers traditional solar control. Tinted products support energy efficiency in regions that rely on air conditioning and low levels of light reflection. Can be tempered, laminated, heat-strengthened. Ideal for use in atriums, skylights, windows, entrances and storefronts. Gray Glass will provide a contemporary look while at the same time offering benefits that makes it a popular choice in architectural and display applications alike.

Glass Thickness		Visible Light		UV Transmittance	Solar Heat Gain Coefficient (SHGC)	Winter U-Value English Btu/(Hr x Sqft x °F)	Winter U-Value Metric W/(M ² x K)
mm	inches	Transmittance (VLT)	Exterior Reflectance				
3mm	1/8"	60.3%	6.4%	37.4%	0.68	1.04	5.90
5mm	3/16"	50.4%	5.9%	28.8%	0.62	1.03	5.86
6mm	1/4"	44.5%	5.6%	24.2%	0.58	1.02	5.82
10mm	3/8"	27.7%	5.0%	13.2%	0.47	1.00	5.69
12mm	1/2"	18.0%	5.0%	N/A	0.42	0.98	5.59



Green Glass

Green Glass offers some solar control. Tinted products supports energy efficiency in regions that rely on air conditioning and low levels of light reflection. Ideal for use in atriums, skylights, windows, entrances and storefronts. Green Glass can provide a fresh, vibrant look to architectural designs while at the same time providing an excellent option to products that contain light-sensitive contents due to it's moderate protection of UV radiation.

Glass Thickness		Visible Light		UV Transmittance	Solar Heat Gain Coefficient (SHGC)	Winter U-Value English Btu/(Hr x Sqft x °F)	Winter U-Value Metric W/(M ² x K)
mm	inches	Transmittance (VLT)	Exterior Reflectance				
6mm	1/4"	53.2%	6.0%	25.5%	0.63	1.02	5.82



Pattern 62 Obscured Glass

This pattern combines an attractive appearance with obscurity and light transmission capabilities, perfect for a range of residential and commercial applications. Mostly used in jalousie windows and kitchen cabinet doors. Also known as Nashiji, Dew or Crepe.



Rain Patterned Glass

Rain patterned glass option bring natural beauty indoors, offering obscurity, light diffusion and rippled pattern reminiscent of a summer shower. Mostly used in shower enclosures. Also known as Niagara.



Reeded Glass

Reeded glass is a type of textured glass featuring a series of parallel lines, or "reeds," which create a distinctive, decorative pattern. It's mostly used in doors, windows, cabinets, partitions and shower enclosures. Also known as Moru.



Aquatex

Aquatex glass is a type of patterned glass that was often used for privacy in various settings, such as bathroom windows, enclosures and patio tables. It can be tempered for safety to be used in areas like shower enclosures or exterior windows where safety glass is required by building codes. Also known as Aqualite.

Glass Thickness		Visible Light		Thickness Tolerance (mm)	Solar Transmission (%)	Solar Reflectance (%)	Winter U-Value Metric W/(M ² x K)
mm	inches	Transmittance (VLT)	Exterior Reflectance				
3.2mm	1/8"	89%	8.0%	(+/-) 0.3	85	8.3	5.80
5mm	3/16"	88%	8.0%	(+/-) 0.4	85	8.0	5.80
6mm	1/4"	87%	8.0%	(+/-) 0.5	83	8.0	5.80
10mm	3/8"	82%	8.0%	(+/-) 0.8	79	8.0	5.80

SATIN ACID-ETCHED GLASS



Satin Acid-Etched Clear Glass

Acid-Etched Glass, with a smooth satin finish appearance, creates a distinctive look that responds to current design trends toward minimalist and simplicity. Combines a satin finish with a smooth, translucent appearance. It filters light, smooths visual contours, and provides obscurity and privacy. Has a slight green tint. Commonly used in shower enclosures, obscurity windows, table tops, office partitions, closets, cabinets, picture frames, etc.



Satin Acid-Etched Low-Iron Glass

Low-Iron Acid-Etched glass, is a specialty glass that combines properties to give unique looks and performance. For instance, it has a frosted appearance with high clarity. It's common applications include doors, shower enclosures, tabletops and places where privacy is needed while at the same time allowing it to have natural light. Its neutral tone eliminates color changes.



Base Glass: Clear Float Glass or Ultra-Clear Low-Iron Float Glass

Application: Cutting, Polishing, Beveling, Bending, Tempering, Lamination

Characteristic	AVCP	NPD
Safety in the case of fire:		
Resistance to fire (13501-2)	1	NPD
Reaction to fire (13501-1)	3,4	A1
External fire behavior (EN 13501-5)	3,4	A1
Safety in use:		
Bullet resistance (EN 1063)	1	NPD
Explosion resistance (EN 13541)	3	NPD
Burglar resistance (EN 356)	4	40K
Pendulum body impact resistance (EN 12600)	4	40K
Resistance against sudden temperature changes		
Temperature differentials	unit 4	10mm
Wind, snow, permanent and imposed load resistance of the glass. Protection against noise:	4	32 (-2;-3)dB
Direct airborne sound reduction (EN12758)		
Light transmission (EN 410):	3	80.1%



Black Back Painted Glass

Black Painted Glass is an ideal solution for commercial and residential spaces, mostly used in interior decor to show a piano black glossy look. Not temperable. Apply Safety back Cat II tape recommended.



White Back Painted Glass

Low-Iron White Painted Glass is an ideal solution for commercial and residential spaces, mostly used in back-splashes and closet doors. Not temperable. Apply safety back Cat II recommended.

Back Painted Glass is a lacquered glass with an opaque and colored appearance, attained by depositing and banking highly resistant lacquer onto the rear surface of the glass. This glass brings color and ambiance to interiors and is particularly suitable for more demanding locations such as bathrooms and kitchens.

Some of its common applications include: homes, offices, hotels, shops and museums. This is by creating smooth, homogenous surfaces as all-panelling, in furniture and in wardrobe and cupboard doors.

Some of the advantages of using this glass include: Inspiring modern-day design, durable and flawless finish, resistant to humidity and safety as well as an elegant and serene installation to the places it's placed at.



LAMINATED GLASS

Meets Standards:

ASTM C1172-14	Complies with category II rating under the 16 CFR 1201 Regulation.
EN14449	
ISO 12543	
ANSI Z97.1	

Visible Light Transmittance (VLT): The percentage of the visible spectrum (light) that is transmitted through the glass.

SHGC: The fraction of incident solar radiation admitted through the glass, both directly transmitted and absorbed and subsequently released inward. SHGC is expressed as a number between 0 and 1. The lower a glass solar heat gain coefficient; the less solar heat it transmits.

Winter U- Value: Measure of the insulating characteristics of the glass in which how much heat gain or loss occurs through the glass due to the difference of indoor and outdoor temperatures using NFRC winter nighttime environmental conditions of a cold outside temperatures and no sunlight.

Hurricane Impact Resistant Glazings: To meet the requirements of the ASTM E 1996 Small Missile Test, laminated glasses typically include a PVB interlayer with a thickness of 0.06" (1.52 mm) and for the Large Missile Test an interlayer of 0.090" (2.28mm) is required.



Clear Laminated Glass

Laminated glass is two or more lites (pieces) of glass permanently bonded together with one or more plastic interlayers (PVB: polyvinyl butyral) using heat and pressure. Laminated glass can be broken, but the fragments will tend to adhere to the plastic layer and remain largely intact, reducing the risk of injury.

Applications: Windows, Storefronts, Jewelry Showcases, Railings.

Glass Thickness		Makeup / Composition	VLT%	SHGC	Winter U-Factor
mm	inches				
6.76mm	1/4"	1/8" Clear Glass + 0.030" Clear PVB + 1/8" Clear Glass	88	0.79	1.00
8.28mm	5/16"	1/8" Clear Glass + 0.090" Clear PVB + 1/8" Clear Glass	88	0.76	0.96
10.38mm	3/8"	3/16" Clear Glass + 0.015" Clear PVB + 3/16" Clear Glass	87	0.76	0.97
12.28mm	7/16"	3/16" Clear Glass + 0.090" Clear PVB + 3/16" Clear Glass	87	0.72	0.94
12.76mm	1/2"	1/4" Clear Glass + 0.030" Clear PVB + 1/4" Clear Glass	87	0.75	0.96

Some features that Laminated Glass has is that it:

1. Provides Safety measures as when glass breaks it adheres to the plastic interlayer rather than breaking into pieces like common annealed glass.
2. Sound Insulation is also one of the characteristics as the PVB interlayer present in the laminated glass can absorb sound waves and reduce sound.
3. Laminated glass is used due to it's tough breakage.
4. Used in areas where Hurricanes, Tornados and Earthquakes are common as it can stand heavy wind loads and impact.

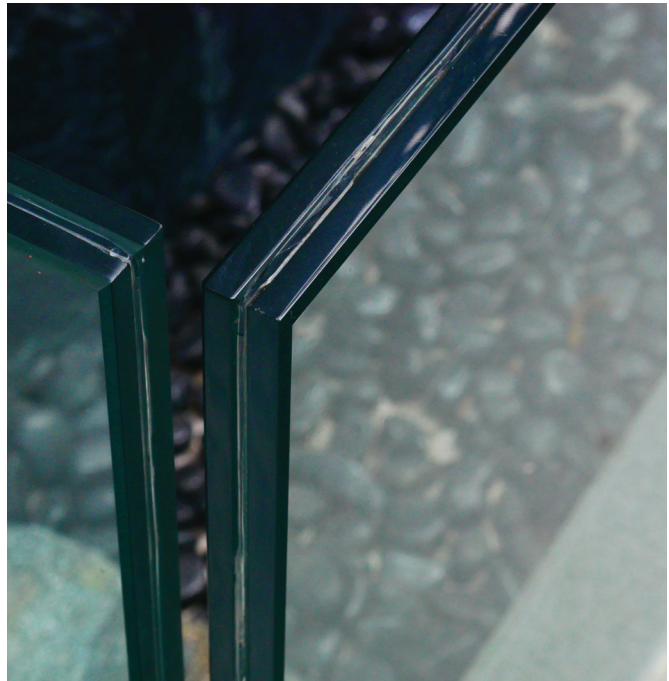



Bronze Laminated Glass

Bronze Laminated Glass has a bronze tint that provides an attractive appearance to buildings and structures. By having the interlayer, Laminated Glass offers safety in case of breakage. This is due to the interlayer holding the glass fragments together preventing them from scattering and causing harm. Also, laminated glass can help in the reduction of solar heat gain in the buildings interior.

Glass Thickness		Makeup / Composition	VLT%	SHGC	Winter U-Factor
mm	inches				
6.76mm	1/4"	1/8" Bronze Glass + 0.030" Clear PVB + 1/8" Bronze Glass	51	0.59	1.00
8.28mm	5/16"	1/8" Bronze Glass + 0.090" Clear PVB + 1/8" Bronze Glass	50	0.58	0.96
12.28mm	7/16"	3/16" Bronze Glass + 0.090" Clear PVB + 3/16" Clear Glass	57	0.59	0.94

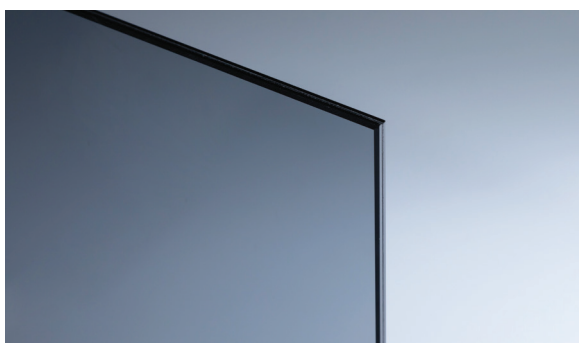

Gray Laminated Glass

Gray Laminated Glass has a gray tint that gives a modern and stylish appearance to buildings and structures. This tint also provides a touch of elegance and sophistication to the architectural needs. Also, it is utilized in interior designs for decorative elements and furniture.

Glass Thickness		Makeup / Composition	VLT%	SHGC	Winter U-Factor
mm	inches				
6.76mm	1/4"	1/8" Gray Glass + 0.030" Clear PVB+ 1/8" Gray Glass	42	0.55	1.00
8.28mm	5/16"	1/8" Gray Glass + 0.090" Clear PVB+ 1/8" Gray Glass	41	0.55	0.96
12.28mm	7/16"	3/16" Gray Glass + 0.090" Clear PVB +3/16" Clear Glass	49	0.55	0.94



Green Laminated Glass

Green Laminated Glass is a safety glass that offers solar protection. Used in windows and doors. Sometimes used when replacing broken automotive glass.

Application: Architecture and Building Design, Interior Design, Solar Panels, Security and Safety.

Glass Thickness		Makeup / Composition	VLT%	SHGC	Winter U-Factor
mm	inches				
6.76mm	1/4"	1/8" Green Glass + 0.030" PVB + 1/8" Green Glass	75	0.57	1.00

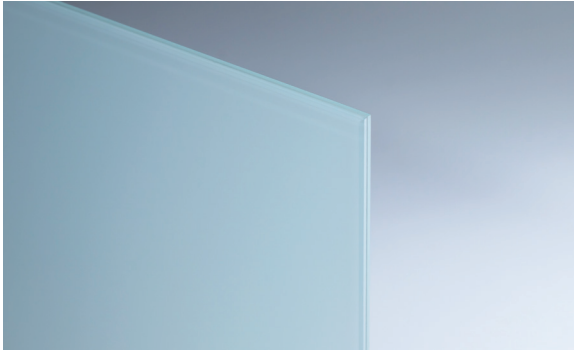

Milky White Laminated Glass

Laminated glass is two or more lites (pieces) of glass permanently bonded together with one or more plastic interlayers (PVB: polyvinyl butyral film) using heat and pressure. Laminated glass can be broken, but the fragments will tend to adhere to the plastic layer and remain largely intact, reducing the risk of injury.

Application: Closet doors, kitchen cabinets, bathroom windows.

Glass Thickness		Makeup / Composition	VLT%	SHGC	Winter U-Factor
mm	inches				
6.76mm	1/4"	1/8" Clear Glass + 0.030"White PVB + 1/8" Clear Glass	63	0.65	1.00



Gray/White Laminated Glass

Laminated glass is two or more lites (pieces) of glass permanently bonded together with one or more plastic interlayers (PVB: polyvinyl butyral film) using heat and pressure. Laminated glass can be broken, but the fragments will tend to adhere to the plastic layer and remain largely intact, reducing the risk of injury.

Application: Closet doors, kitchen cabinets, bathroom windows.

Glass Thickness		Makeup / Composition	VLT%	SHGC	Winter U-Factor
mm	inches				
8.28mm	5/16"	1/8" Gray Glass + 0.76" Milk White PVB + 1.52 Clear PVB + 1/8" Gray Glass	39	0.54	5.46
12.28mm	7/16"	3/16" Gray Glass + 0.76" Milk White PVB + 1.52 Clear PVB + 3/16" Gray Glass	24	0.46	5.34

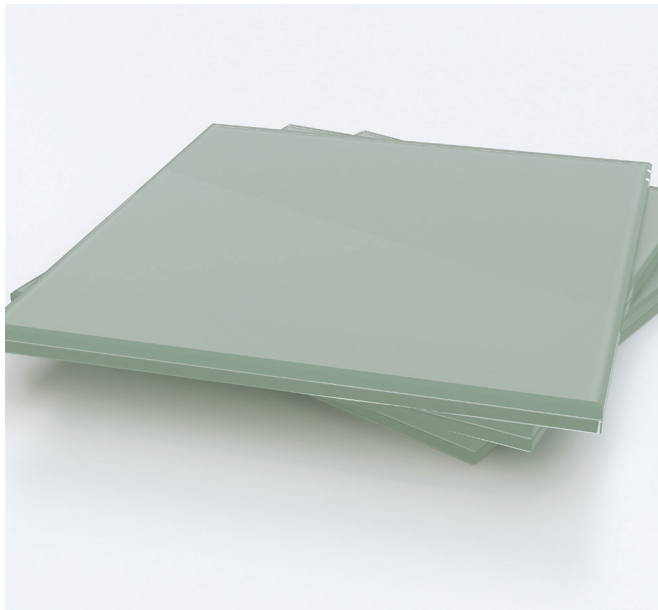



MIRRORS

Meets Standards:

ASTM C1172-14

Copper-Free Mirror: This is the most corrosive resistant silver mirror in the market. It is used in doors, wall covering, retail displays and fixtures, furniture and case goods, surfaces and tables. Available in clear, low iron, bronze, and gray tints.



Clear Mirror

This is the most common silver mirror which provides unparalleled protection against corrosion, chemicals moisture and abrasion while adding beauty and elegance to any room. It is used indoors in, wall coverings, retail displays and fixtures, furniture and showcases, surfaces and tables, vanities and more.

Benefits of Using Clear Mirror:

Excellent resistance to humidity. Strong performance in accelerated corrosion testing, including CASS and salt spray. Higher resistance to a wide range of household chemicals than traditional copper-manufactured mirrors. Reduced clouding due to copper oxidation, yielding a superior mirror product. Contributes to environmental protection by elimination of toxic products (i.e. Copper, ammonia and lead) during production. Improved resistance to aggressive agents in certain cleaning products.

Characteristic	Technical Requirements
Size Tolerance	± 2.0mm
Thickness tolerance	±0.3mm
Diagonal Difference	<diagonal average length's 0.2%
Reflection Side:	
Punctate defects	≤0.2 mm no counting 0.2-0.3mm, qty:1.35/m ² 0.3-0.5mm, qty: 0.16/m ² 0.5-1.0mm , qty: 0.1/m ²
Thread defects	Bruchmark length ≤ 50mm, qty: 8/m ² Mirror surface scratch length ≤ 50mm, qty: 3/m ²
Chipped/crack edge	Length/Width/Depth not exceed mirror thickness
Edge concave-convex	Not exceed 1/2 of mirror thickness
Corner concave-convex	Not exceed mirror thickness
Mildew stain	Macroscopic defects not allowed
Back Paint:	
Visible back paint scratch	Not allowed
Non-visible back paint scratch	Scratch length≤50mm, qty: 10/m ² Scratch length≤50mm, qty: 2/m ²
Back paint dropped	Not allowed
Performance:	
Silver content in silver film	≤800 mg/m ²
Lead content silver film	≤100mg/m ²
Silver film's pencil hardness	≥2H
Protective layer adhesion	Row lattice method ≤ 2 grade.
Slat Spray test	Allow color fade in protective layer but not allowed bubbles in the surface: reflective layer doesn't allowed fade or muddy, 0.3 ≤ stain diameter >0.2 mm, allowed qty: 2, edge corrosion ≤ 1.5mm
Heat-resisting/moisture-proof	Reflective layer without fade Back paint not dropped
Visible light reflectivity	≥85



LOW IRON MIRROR



Low-Iron Mirror

Low-Iron Mirror is characterized by a higher transparency and more neutral color, making it ideal where high reflection and clarity are required. Some of the features of this type of mirror are: brighter reflections, sharper focus, clearer images, better color, natural skin tones, whiter whites. Is use in most high-end places like spas, salons and retail spaces.

Benefits of Using Low Iron Mirror:

Due to its superior clarity, Low Iron Mirror reduces the greenish tint found in regular mirrors. This allows it to have greater enhanced clarity. True Color Reflection makes a significant difference as colors are reflected more accurately. This is the reason why Low Iron Mirror's are used in dressing rooms, makeup studios or art galleries. Low Iron mirror provides aesthetic superiority making the product be more appealing in modern designs. Durable and Long-lasting are one of the key benefits of using Low-Iron Mirrors.

Characteristic	Technical Requirements
Size Tolerance	±6.0mm
Thickness tolerance	±0.2mm
Diagonal Difference	Less than 0.2% diagonal average length
Reflection Side:	
Punctate defects	≤0.3mm, no count 0.3-0.5mm, 2/m ² 0.5-1.0mm, 1/pcs >1.0mm, not allow
Thread defects	Brush marks Length ≤ 50mm, 10 pieces/m ² Mirror scratch Length≤50mm,5 pieces/m ²
Chipped/crack edge	Length, width and depth do not exceed the thickness of the mirror
Edge concave-convex	No more than 1/2 mirror thickness
Corner concave-convex	No more than mirror thickness
Mildew stain	Visible defects are not allowed
Back Paint:	
Visible back paint scratch	Not allowed
Non-visible back paint scratch	Length≤50mm, 10 pieces /m ² Length>50mm, 2 pieces/m ²
Back paint dropped	Not allowed
Performance:	
Silver content in silver film	≥730mg/m ²
Lead content silver film	
Silver film's pencil hardness	≥2H
Protective layer adhesion	Grid determination≤2 grade Allow discoloration on the protective layer, not allow bubble on surface Not allow discoloration or turbidity on the reflective layer
Slat Spray test	0.3≤Spot diameter>0.2mm Allow 2 Edge corrosion≤1.5mm
Heat-resisting/moisture-proof	Reflective film color not change Back paint without peeling
Visible light reflectivity	≥90





Gray Mirror

Gray Mirror is a very modern decorative tinted mirror and a great way to incorporate a sleek masterpiece of low-keyed eloquence into one's mirror decor. Transform your space with an elegant reflection found only in the most sophisticated of spaces. With its cool tone it is popular in modern closets, and spaces like restaurants and elevators.



Bronze Mirror

Bronze Mirror is a very modern decorative mirror and great way to incorporate a sleek copper hue into one's mirror decor. Popular in fancy restaurants and bars, stylish bathrooms and in the home. Transform your space with an elegant reflection found only in the most sophisticated of spaces. Provides a warm tone finish.

Characteristic	Technical Requirements
Size Tolerance	± 2.0mm
Thickness tolerance	±0.3mm
Diagonal Difference	<diagonal average length's 0.2%
Reflection Side:	
Punctate defects	≤0.2 mm no counting 0.2-0.3mm, qty: 1.35/m ² 0.3-0.5mm, qty: 0.16/m ² 0.5-1.0mm , qty: 0.1/m ²
Thread defects	Bruchmark length ≤ 50mm, qty: 8/m ² Mirror surface scratch length ≤ 50mm, qty: 3/m ²
Chipped/crack edge	Length/Width/Depth not exceed mirror thickness
Edge concave-convex	Not exceed 1/2 of mirror thickness
Corner concave-convex	Not exceed mirror thickness
Mildew stain	Macroscopic defects not allowed
Back Paint:	
Visible back paint scratch	Not allowed
Non-visible back paint scratch	Scratch length≤50mm, qty: 10/m ² Scratch length≤50mm, qty: 2/m ²
Back paint dropped	Not allowed
Performance:	
Silver content in silver film	≤800 mg/m ²
Lead content silver film	≤100mg/m ²
Silver film's pencil hardness	≥2H
Protective layer adhesion	Row lattice method ≤ 2 grade.
Slat Spray test	Allow color fade in protective layer but not allowed bubbles in the surface: reflective layer doesn't allowed fade or muddy, 0.3 ≤ stain diameter >0.2 mm, allowed qty: 2, edge corrosion ≤ 1.5mm
Heat-resisting/moisture-proof	Reflective layer without fade Back paint not dropped
Visible light reflectivity	≥85

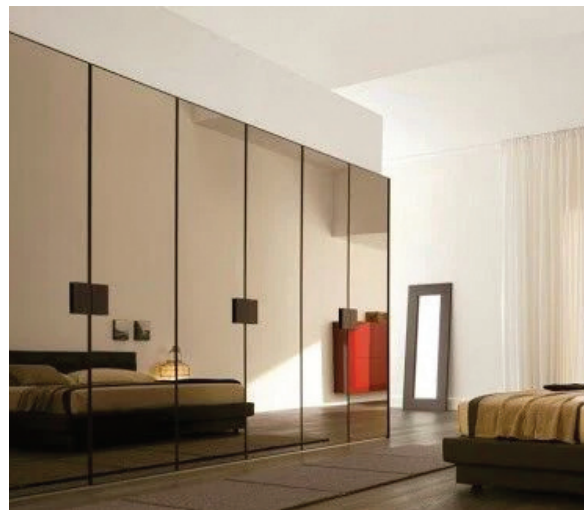

ANTIQUE & SATIN MIRROR



Antique Mirror (French)

Antique Mirror is designed to offer a subtle retro appearance in any interior scheme. Offering a warm reflection high versatility. Can be used in a range of applications like large wall spans in interiors, lobbies, stylish commercial interiors, restaurants and bars, antique furniture, etc.

Some of the advantages of having antique mirror include: It's authentic decorative appearance, high durable and easy to maintain and safety makes Antique Mirror one of the most popular choices for interior design. Following the standard EN 1036, Antique mirror is for internal use only.

Offering a subtle and warm light, antique mirror is a highly versatile and can be applied in a range of applications to suit the designer and offer limitless design opportunities when combined with other materials such as wood, metal and marble.

Glass Thickness		Visible Light		Declared Emissivity	G-Value	Solar Reflectance (%)
mm	inches	Temperature Changes and temperature differentials	Exterior Reflectance			
6mm	1/4"	40	0.90/0.04	0.89	0.05	0.77/0.05

*The performance of the product is in conformity with the declared performances. This declaration of performance is issued under the sole responsibility of the manufacturer.



Satin Mirror

Satin Mirror will bring both a modern and an eye-catching perspective to your living space. Due to special washing and production the product has a non-fingerprint and scratch resistant features, produced using clear mirror as the base.



Some of the most important applications of the Satin Mirror include:

1. Decorative surfaces & mirrors
2. Furniture, caseloads & surfaces
3. Staircases & railings
4. Walls & Partitions
5. Interior Partitions
6. Office enclosures
7. Shower and Bath enclosures
8. Interior and Exterior doors

Technical Information:

Satin Mirror has passed the following test:

Taber test, Erichsen test, Condensation resistance, Acid water resistance, Resistance to neutral salt spray, reflection: Value: Coating side $\geq 58\%$ **

Transmittance: 3% *



One-Way Mirror

One-Way Mirror is a reflective coated glass which offers an effective means of providing undetected surveillance and high quality one-way vision to achieve complete privacy. Ideally used in interrogation rooms, computer rooms, banks or cash offices. This glass must be installed with the coating on the subject's (observed person) side.

Some of the most important characteristics of One Way Mirror include:

- 1. Transparency and Reflection:** The coating in the mirror allows it to be reflective and transparent due to its transparent layer of metal.
- 2. Lighting Conditions:** One-Way Mirror relies on lighting conditions on either side.
- 3. Directional Privacy:** One-Way Mirrors are used for privacy features, in areas where security is promoted. People on one side can see through but on the other side they can only see their reflection.
- 4. Versatility:** One Way Mirrors are used in various areas like entertainment, technology and scientific research.
- 5. Thickness and Durability:** This glass varies in thickness and has different applications.

Glass Thickness		Optical Performance	Solvent Resistance	Alkali Resistance	Acid Resistance	Hot & Humid	Salt Spray Test	Adhesive Force	Thickness Tolerances	Length/Width Tolerances
mm	inches									
6mm	1/4"	Film surface reflection 30+-3% glass surface reflection 60 +- 3% transmission 10 +- 3%	25°C 72 Hours	40°C 5% NaOH, 1 Hours	25°C, 5%H ₂ SO ₄ , to 24 Hours	85°C 85%RH 48 Hours	Neutral salt spray test, 5%NaCl salt solution, PH 6.5-6.8 96h 48hCASS test PH 3.1-3.3 Copper accelerates acetate spray 48h	Strip bottom test with 3M tape	+/-0.2mm	+/- 1mm

In inspection the film layer does not fall off
Result: Qualified and meets the required standards.





GLAZING TOOLS

Water Resistant Labels

NS-2000



500 labels per roll specially designed for the glass industry. Easy to peel off. Water resistant. Label size 4" x 4". Recommended use with thermal printer Zebra GK420T. Glossy Finish.

Stick-On Sanding Discs



Disc Size	Grit	Code
6"	80 Grit	PSA680
6"	120 Grit	PSA6120
6"	400 Grit	PSA6400

CRL Abrasive Sanding discs to use with the Makita GV5010 Disc Sander, or similar. Use to grind or polish glass or mirrors edge.

Stick-On Disc Replacement Pad 6"

PAD6



Attach this pad to the Makita disc sander to be able to use adhesive discs. For 6" discs only.

Cork Separator Pads



Cork pads with static foam (Non-Adhesive) for separating glass. Peels off without leaving residue. Pad Size: 3/4" x 3/4"

Recommended:
1/8" cork for 3/32" - 1/4" glass.
1/4" cork for 3/8" - 3/4" glass.

1/8" Thick (25,000/roll) NS-303

1/4" Thick (11,667/roll) NS-306

Gauntlet Cuff Palm Gloves (Pair)

GT-GG01



Special smooth, natural rubber coating on the palm side with freedom of hand movement.

Tuff-N-Lite® Halo Interlock Jacket

JAIMT241



- Full body zipper jacket with abdominal cut reinforcement.
- Uses Complex Ultra-Light Yarn Blends.
- Unaffected by moisture or UV radiation.
- Keeps user cool in hot conditions.

Wood Crate Slings

SL120281



For wood cases handling using a 10,000 lbs forklift boom or 3 Ton overhead crane. Adjustable for 48" x 84" up to 96" x 144" cases.

Tuff-N-Lite® Gripper Gloves

GL668



- Rubber-coated grip pattern provides excellent wet & dry grip.
- Comfortable, cut-resistant composite liner for all-day wear.

Polishing Spray Oil

CRL920



Contents: 11 oz Can. Polishing oil used to lubricate the belts or sanding discs for a smooth clear finish.

Tuff-N-Lite® Interlock Apron

ANINT037



- Apron come with extra protection in lower body & groin area with adjustable leg & waist straps.

Diamantor Glass Cutter

BO-200.1



DIAMANTOR

One steel wheel with 130° cutting angle. Straight edge stand-off distance 1/16" (1.5mm). Disposable. Wood handle. For 3/32" (2.3mm) up to 1/4" (6mm) glass.

GLASS & MIRROR INSTALLATION TOOLS

Oval Mirrors

M-602436

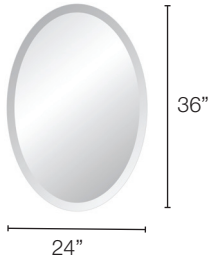

1/4" Oval Shape Copper-free Mirror with 1" bevel. Mostly used in bathrooms. Does not include mounting hardware.

Beveled Mirror Strips

S-6R2120
S-6R3120

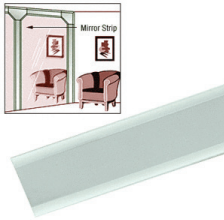

Available in:
2" x 120"
3" x 120"

Palmer Mirro-Mastic® Can

PM201GL



Contents: 1 Gallon Can.
This mirror adhesive will not damage mirror silvering. Stays live and won't crack or dry. Allows movement due to normal thermal changes. Qualifies for LEED. Fully cures in 45 days. Full body.

Mounting Foam Tape

CRL423212

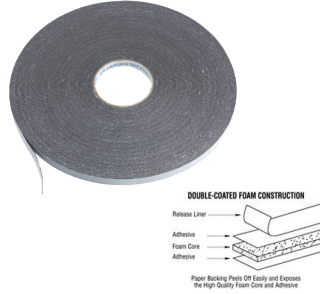

Color: Black
Size: 1/32" Thick x 1/2" Wide x 200" Length.
Double Face Tape to mount mirrors on various surfaces. Chemically compatible with all coatings and will not cause ghosting.

Xtragrip™ Green Mirror Adhesive

BO-6002009



Contents: 10 oz Cartridge
Environmentally friendly mirror adhesive. High tack and fast grab formula. Very high strength capability. Light body. Qualifies for LEED

Palmer Mirro-Mastic® Cartridge

PM601T



Contents: 11 oz Cartridge.
Palmer Mirro-Mastic® in cartridges is the same high quality adhesive mastic that is in the can. It is formulated for adhering plate glass mirror and acrylic mirror to various substrates, such as drywall, wood, glass, metal, and tile. Full body. Qualifies for LEED.

Safety Back Tape

SBT48

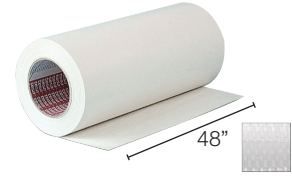

Size: 48" Width x 250' Length
Category II Tape makes Mirrors Shatter Resistant. Keeps glass fragments from causing serious bodily damage. This pressure-sensitive, adhesive coated film tape is primarily recommended for mirrored closets or walls.

Complies with: ANSIZ97.1-2009.
16CFR1201

Single Acrylic Mirror Outlet Plate

PMP102



Double Acrylic Mirror Outlet Plate

PMP202



Material: 1/8" Mirror-Backed Acrylic.
Covers Switch and Outlets. Drilled for standard size mounting screws.

L-Channel Moulding

L-CH12D



Material: Aluminum
L-Mouldings can be used for inside and outside corners. Use it on wall mirrors where a lower lip is not required.

Deep J-Channel Moulding

J-CH12D

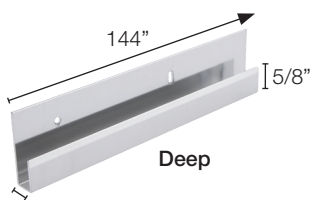

5/16" (8mm)

Shallow J-Channel Moulding

J-CH12W

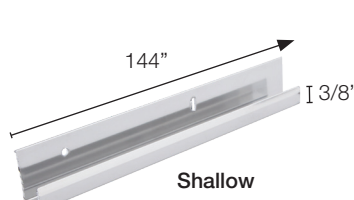

3/8" (10mm)

Material: Aluminum
Stock Length: 144"

J-Moulding are designed to be used below or on top of 1/4" mirror and allows for irregular wall surfaces.

It provides extra room for application of light bodied mirror mastics or foam mirror mounting tapes when using the Deep Moulding. Full body Mirro-Mastic can only be used with the Shallow Moulding.

GLASS & MIRROR INSTALLATION TOOLS

Gunther Ultra/Bond® Mastic

GN100A



Contents: 10 oz Cartridge.
Gunther Ultra/Bond® Mastics is a high quality adhesive formulated to provide a strong, permanent bond between electro-copper-plated glass mirror and various substrates. Light body.

Mildew Resistant Clear Silicone Sealant

33SMRC



Contents: 10 oz Cartridge
General purpose acetoxy cure clear silicone sealant/adhesive. Mildew resistant; making it perfect for shower enclosures. It is a one component, room temperature curing, 100% silicone elastomer that does not require activators, stabilizers or catalysts to achieve optimum performance.

Substrates: Glass, aluminum, fiber glass, tile, plastic, ceramic, masonry, concrete, brick and wood.

Hi-Sheen Glass Cleaner

3371100



Contents: 19 oz Can
Industrial strength glass cleaning. Foaming action stays on the glass longer for better results. Ozone safe. HAZMAT.

Wood's Powr-Grip® ABS 8" Suction Cup

B0-6023157



Model G0695. Lightweight, heavy duty handle made of rustproof ABS. Red-line indicator warns user of any significant vacuum loss. Vacuum Pad: 8" [20 cm] diameter. Load Capacity: 125 lbs (56 Kg)

Plastic Setting Blocks

PSB040



Support blocks for frameless installation or inside u-channel.
Dimensions: 1/16" H x 1/4" W x 2" L

Clear-Fusion V (Glass Coating)

CFV120



Contents: 4 oz Bottle
Reduces the amount of staining that occurs with water minerals and calcium build up. Last for more than 200 sqft of Glass surface.

Spear Point Drill Bit



Ceramic/Glass drill bit for use in hand held low rpm power tools.

3/16" [BA-5000905](#)

1/4" [BA-5000906](#)

Single Edge Razor Blades

51S



Super sharp, disposable. Used for cleaning debris in glass. 3 facet blades can be oiled or degreased, depending on application.

Bio-Clean Water Stain Remover

WSR1



Contents: 16 oz Bottle.
Helps removes water and mineral stains, lime scale, calcium, soap scum, among others from glass and other surfaces. Works great on: shower doors, windows, chrome, aluminum, stainless steel, etc



SHOWER HARDWARE

3/8" Clear Tempered Glass Shower Door For Standard Wall Hinge

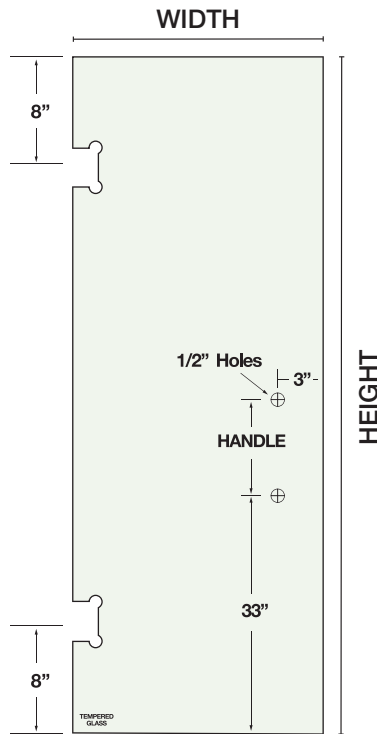

ITEM #	WIDTH	HEIGHT	HANDLE
D-7224	24"	71-5/8"	8"
D-7226	26"	71-5/8"	8"
D-7228	28"	71-5/8"	8"
D-7626	26"	75-5/8"	8"
D-7628	28"	75-5/8"	8"
D-8026	26"	79-5/8"	8"
D-8028	28"	79-5/8"	8"

Compatible With The Following Hinges

Z-2000	Z-3111	Z-3113	Z-7515
Z-3120	Z-3020	Z-9430	

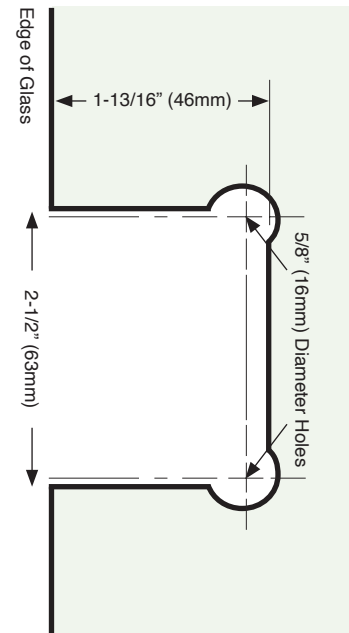

Cut-out Tolerance: +/- 1/16" (2mm)
 Door Tolerance: 1/4" (6mm) Bow
 Conformance with: ASTM C1048-12

3/8" Clear Tempered Glass Shower Door For Heavy-Duty Wall Hinge

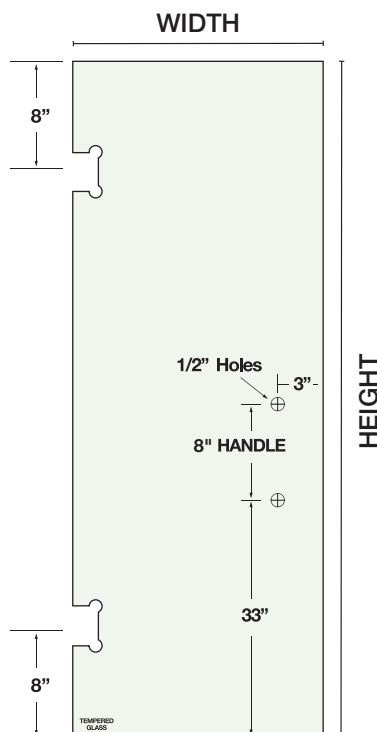

ITEM #	WIDTH	HEIGHT	HANDLE
DH-7628	28"	75-5/8"	8"
DH-8028	28"	79-5/8"	8"
D-8426	26"	83-5/8"	8"
D-8428	28"	83-5/8"	8"

Compatible With The Following Hinges

Z-9111	Z-9113	Z-9712	Z-9120
--------	--------	--------	--------

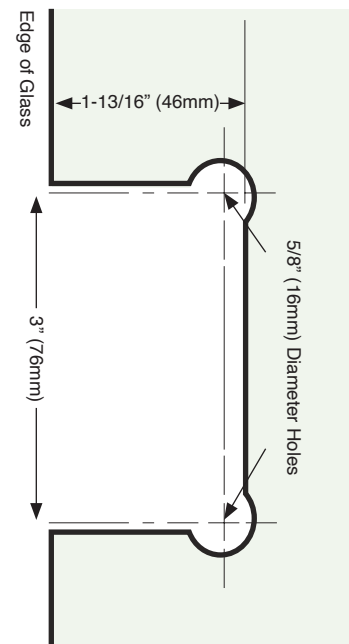

Cut-out Tolerance: +/- 1/16" (2mm)
 Door Tolerance: 1/4" (6mm) Bow
 Conformance with: ASTM C1048-12



WALL MOUNT HINGES

Glass Requirements

- 3/8" (10mm) Tempered Glass
- 1/2" (12mm) Tempered Glass



Specifications

- Solid brass body and clear polyurethane gaskets
- Glass cut-out required
- Screws and gaskets included
- Hinge swings 90° in and 90° out
- Self-centering when within 15° of closed position
- Use thick gaskets for 3/8" glass or thin gaskets for 1/2" glass

Cares

- Can be cleaned with water and a soft cloth
- Use of harsh or abrasive cleaners may harm finish and will void the warranty
- Do not use power tools when installing or spray lubricant on this hinges
- 3 year warranty on Hinges only, all other hardware 1 year warranty

Wall Mount H-Back Square Hinge

Z-2000



- CP
- BN
- MB
- BG

Tight Clearance Cut-Out
Wall Deduction: 1/16" (2mm)

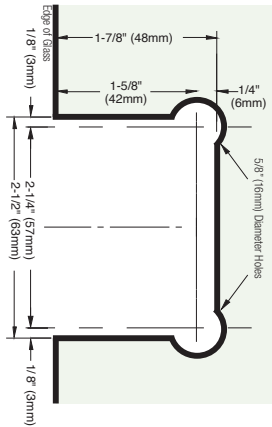

Optional:
Standard Glass Cut-out
with 3/16" deduction

Wall Mount Full-Back Square Hinge

Z-3111



- CP
- BN
- MB

Standard Glass Cut-Out
Wall Deduction: 3/16" (5mm)

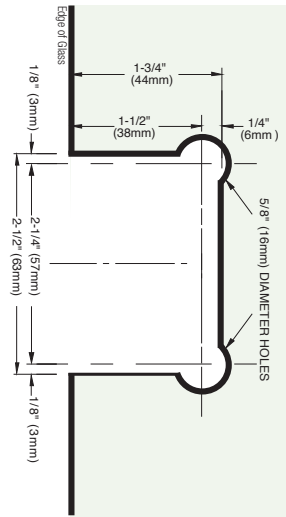

Wall Mount Offset-Back Square Hinge

Z-3113



- CP
- BN
- MB
- BG

Wall Mount Full-Back Adjustable Beveled Hinge

Z-7515



- CP
- BN
- MB

Maximum Door Capacities

2 Hinges | Weight: 75 lbs (34 Kg) | Width: 28" (711mm)
For a heavier load use heavy duty hinges

Heavy-Duty Wall Mount Full Back Square Hinge

Z-9111



- CP
- BN
- MB
- BG

Heavy-Duty Wall Mount H-Back Square Hinge

Z-9117



- CP
- BN
- MB
- BG

Heavy-Duty Wall Mount Offset Back Square Hinge

Z-9113



- CP
- BN
- MB

Heavy-Duty Wall Mount H-Back Adjustable Beveled Hinge

Z-9712



- CP
- BN
- MB
- BG

Heavy-Duty Glass Cut-Out

Wall Deduction: 3/16" (5mm)

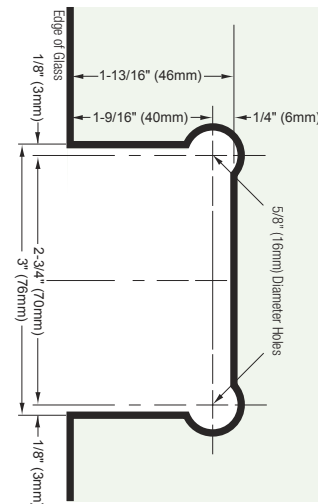

Maximum Door Capacities

2 Hinges | Weight: 110 lbs (50 Kg) | Width: 36" (914mm)
3 Hinges | Weight: 140 lbs (63 Kg) | Width: 36" (914mm)

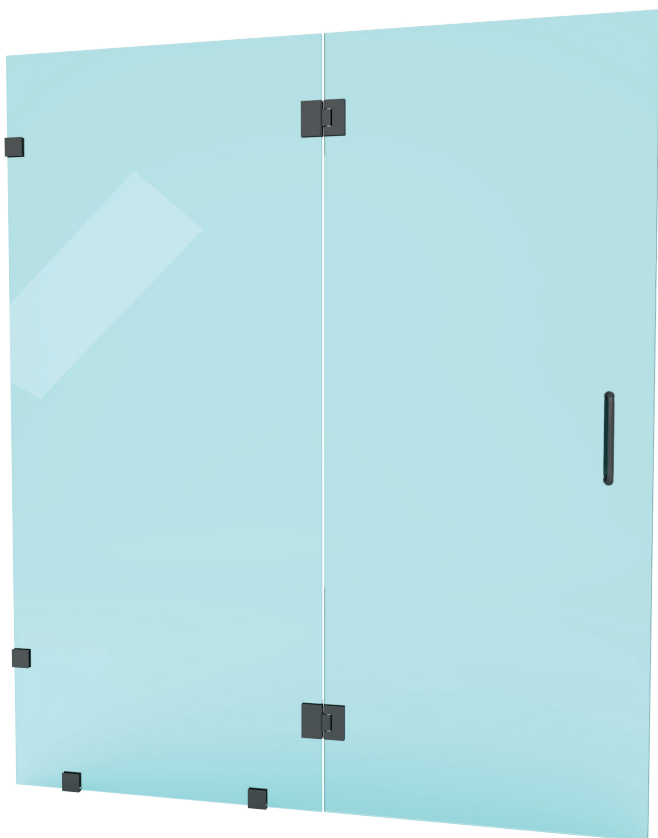

GLASS TO GLASS HINGES

Glass Requirements

- For 3/8" (10mm) Tempered Glass
- For 1/2" (12mm) Tempered Glass



Specifications

- Solid brass body and clear polyurethane gaskets
- Glass cut-out required
- Screws and gaskets included
- Hinge swings 90° in and 90° out with self-centering
- Self-centering when within 15° of closed position
- Use thick gaskets for 3/8" glass or thin gaskets for 1/2" glass

Cares

- Can be cleaned with water and a soft cloth
- Use of harsh or abrasive cleaners may harm finish and will void the warranty
- Do not use power tools when installing or spray lubricant on this hinges
- 3 year warranty on Hinges only, all other hardware 1 year warranty

Glass-to-Glass 180° Square Hinge

Z-3120



Glass-to-Glass 180° Beveled Hinge

Z-3020



Glass-to-Glass 135° Adjustable Square Hinge

Z-9430



Standard Glass Cut-Out

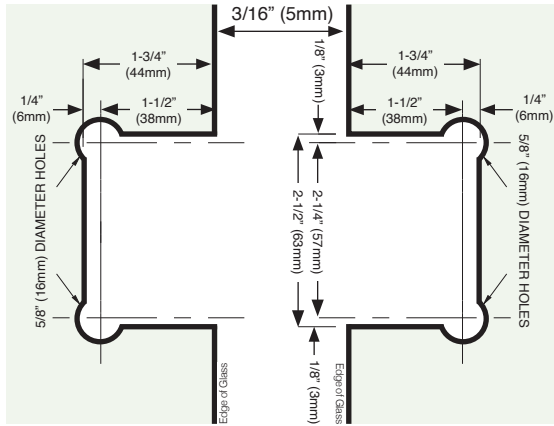

Standard Glass Cut-Out

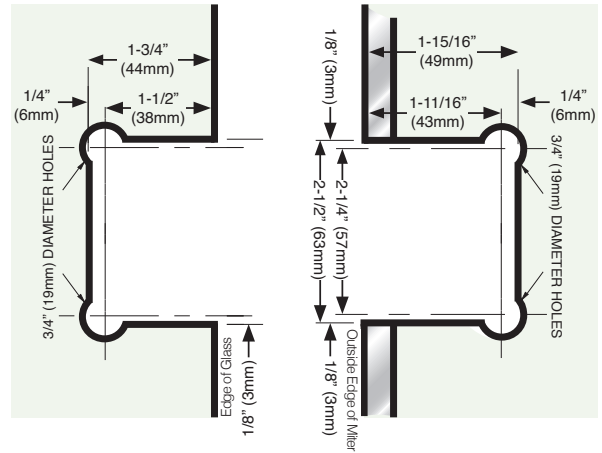

Maximum Door Capacities

2 Hinges | Weight 75 lbs (34 Kg) | Width 28" (711mm)

For a heavier load use heavy duty hinges

Heavy-Duty Glass to Glass 180° Square Hinge

Z-9120



Heavy-Duty Glass Cut-Out

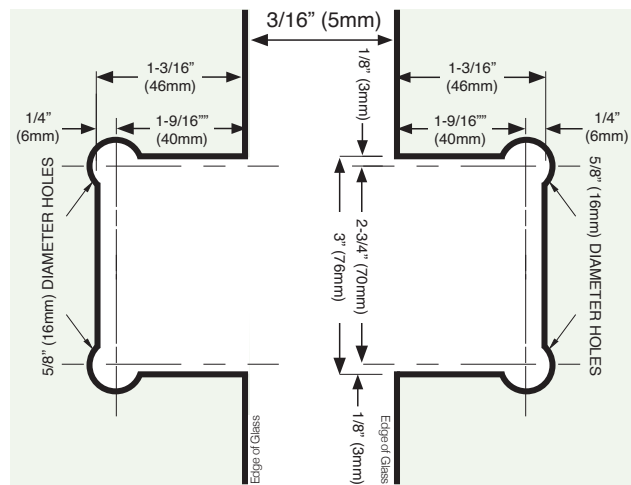

Maximum Door Capacities

2 Hinges | Weight 110 lbs (50 Kg) | Width 36" (914mm)

3 Hinges | Weight 140 lbs (63 Kg) | Width 36" (914mm)

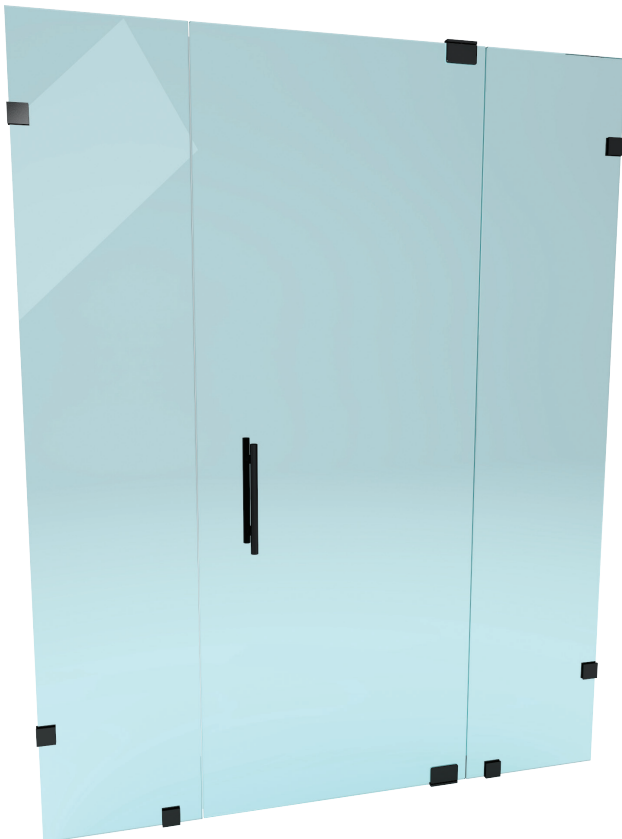

PIVOT HINGES

Specifications

- Solid brass body and clear polyurethane gaskets
- Glass cut-out required
- Screws and gaskets included
- Hinge swings 90° in and 90° out. Self-centering when within 15° of closed position
- Can be mounted floor and ceiling, or floor and wall using the wall adaptor (Z-3835), or adaptor block (Z-HAB01)



Cares

- Clean with water and a soft cloth
- Use of harsh or abrasive cleaners may harm finish and will void the warranty
- Do not use power tools directly on the hinge when installing or spray lubricant on this hinges
- 3 year warranty on Hinges only, all other hardware 1 year warranty

Pivot Square Hinge

Z-3820



- CP
- BN
- MB
- BG

Pivot Beveled Hinge

Z-3830



- CP
- BN
- BG

Standard Pivot Wall Adapter

Z-3835



- CP
- BN
- MB
- BG

Allows Standard Pivot Hinge (Z-3830 or Z-3820) to be left or right hand wall mounted. Without the need of a header.

Standard Glass Cut-Out Deduction: 3/8" (10mm)

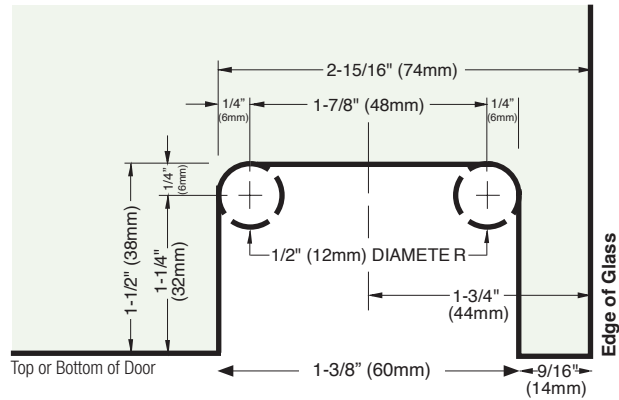

Maximum Door Capacities

2 Hinges | Weight 100 lbs (45 Kg) | Width 31" (787mm)

Glass Requirements

- 3/8" (10mm) Tempered Glass

Heavy-Duty Pivot Square Hinge

Z-3828



- CP
- BN
- MB

Heavy-Duty Pivot Beveled Hinge

Z-3838



- CP
- BN

Heavy-Duty Glass Cut-Out Deduction: 9/16" (13mm)

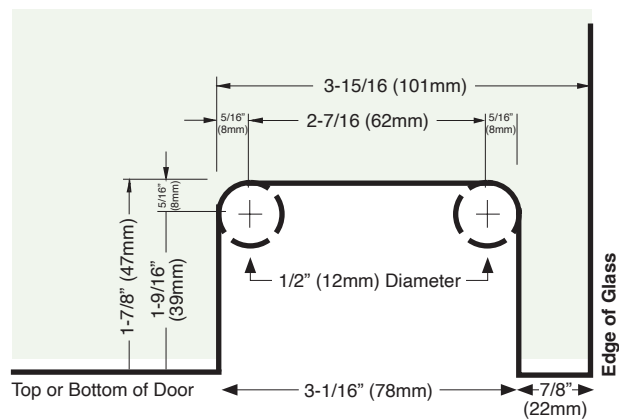

Maximum Door Capacities

2 Hinges | Weight 145 lbs (66 Kg) | Width 36" (914mm)

Glass Requirements

- 3/8" (10mm) Tempered Glass
- 1/2" (12mm) Tempered Glass

HANDLES & TOWEL BARS

Tubular 6" Handle

Z-5310A

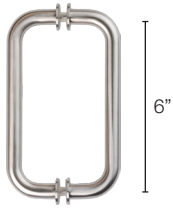

Square 6" Handle

Z-5303A

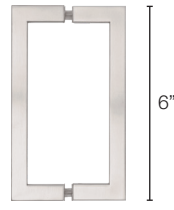

Tubular Ladder 8" Handle

Z-5313B

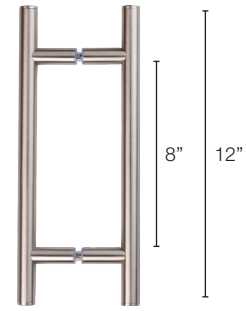

Tubular 8" Handle

Z-5310B

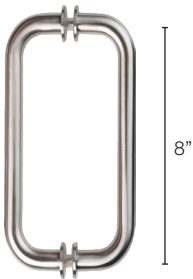

Square 8" Handle

Z-5303B

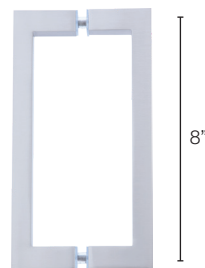

Square Ladder 8" Handle

Z-2043B

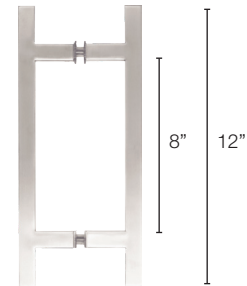

Tubular 24" Towel Bar

Z-5320B



Square 24" Towel Bar

Z-5329B

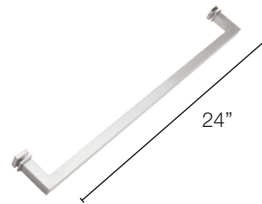

Rounded Knob

Z-5108



Material: Solid Brass

Tubular 8" Handle with 18" Towel Bar Combination

Z-5348



Square 8" Handle with 18" Towel Bar Combination

Z-5358



Square Knob

SK110

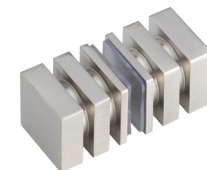

Material: Solid Brass

Glass Requirements

- 1/4" (6mm) Tempered Glass
- 3/8" (10mm) Tempered Glass
- 1/2" (12mm) Tempered Glass

Specifications

- Material: 3/4" (19mm) Stainless Steel
- Hole Diameter Required: 1/2" (12mm)

Cares

- Clean with water and a soft cloth
- Use of harsh or abrasive cleaners may harm finish and will void the warranty
- Do not use power tools directly on the handle when installing or spray lubricant

Square Fixed Panel Clamp

Z-4602



HOLE-IN-GLASS

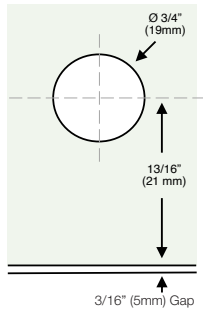

Cut-out used when hanging glass panel from ceiling.

Rounded Fixed Panel Clamp

Z-4401

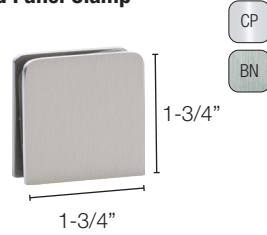

FINGER NOTCH GLASS CUT-OUT

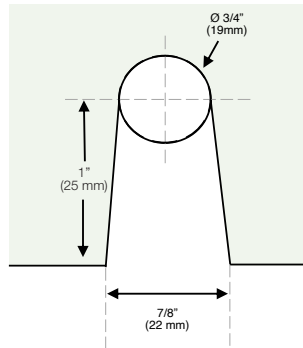

Cut-out used when fixing glass panel to wall or floor.

Heavy-Duty Square Fixed Panel Clamp

Z-4601

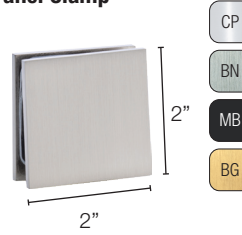

FINGER NOTCH GLASS CUT-OUT

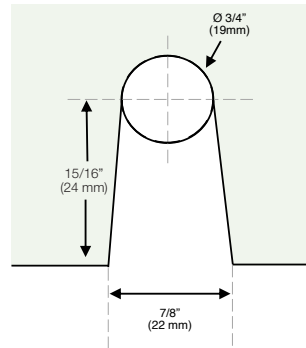

Heavy-Duty Beveled Fixed Panel Clamp

Z-4607

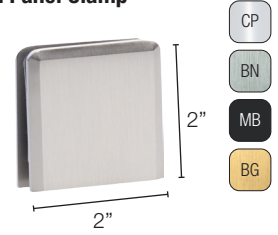

FINGER NOTCH GLASS CUT-OUT

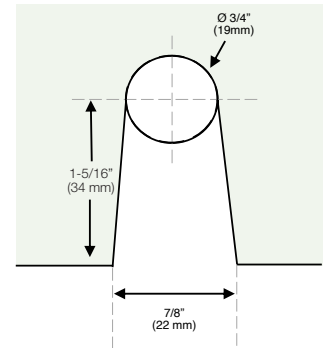

Heavy-Duty Square Fixed Panel Double Screw Clamp

Z-4603



GLASS CUT-OUT

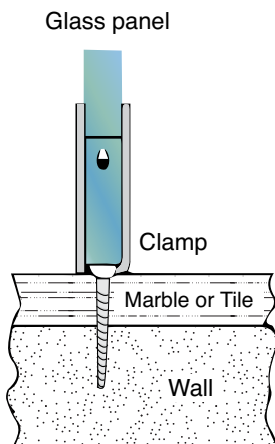
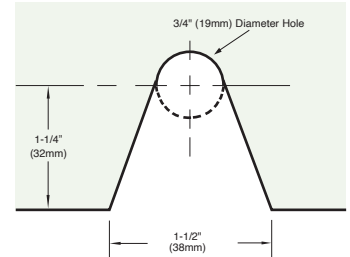

Glass Requirements

- 3/8" (10mm) Tempered Glass
- 1/2" (12mm) Tempered Glass

Specifications

- Solid brass body and clear polyurethane gaskets
- Screws and gaskets included
- Glass cut-out required

Cares

- Clean with water and a soft cloth
- Use of harsh or abrasive cleaners may harm finish and will void the warranty
- Do not use power tools directly on the clamp when installing or spray lubricant

GLASS TO GLASS CLAMPS

Glass-to-Glass 90° Rounded Clamp

Z-4425



Heavy-Duty Glass to Glass 90° Square Clamp

Z-4625

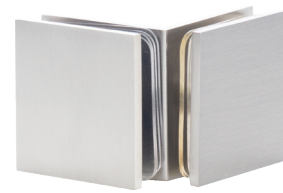

Flat Edge Glass Cut-Out

3/4" (19mm)
Diameter Hole

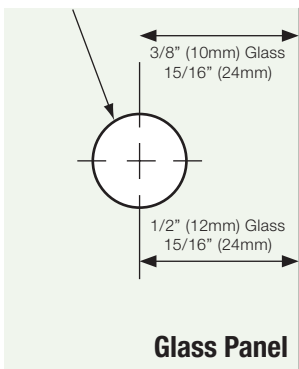

Butting Panel

3/4" (19mm)
Diameter Hole

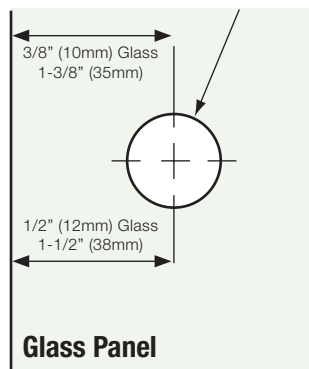

Overlapping Panel

45° Mitered Edge Glass Cut-Out

3/4" (19mm)
Diameter Hole

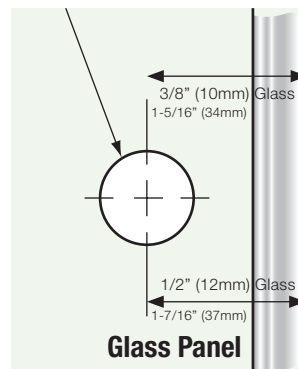

45° Mitered Panel

Outside Edge of Miter

3/4" (19mm)
Diameter Hole

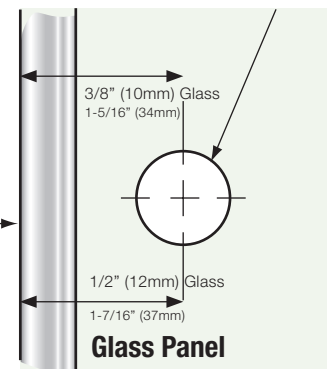

45° Mitered Panel



Glass Requirements

- 3/8" (10mm) Tempered Glass
- 1/2" (12mm) Tempered Glass

Specifications

- Solid brass body and clear polyurethane gaskets
- Screws and gaskets included

Cares

- Can be clean with water and a soft cloth
- Use of harsh or abrasive cleaners may harm finish and will void the warranty
- Do not use power tools directly on the clamp when installing or spray lubricant

Glass-to-Glass 135° Rounded Clamp

Z-4423

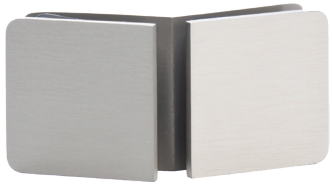

Glass-to-Glass 180° Rounded Clamp

Z-4420



22.5° Mitered Glass Cut-Out

3/4" (19mm) Diameter Hole Outside Edge of Miter 3/4" (19mm) Diameter Hole

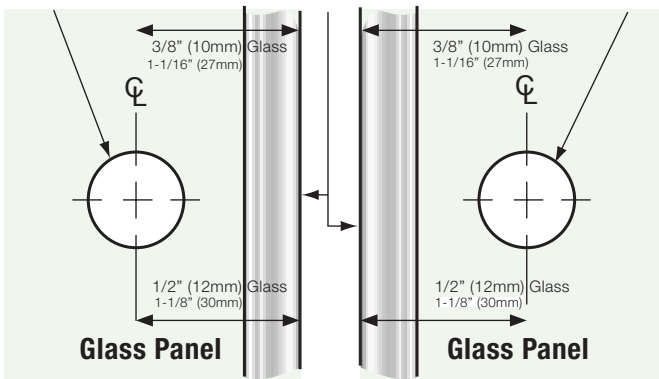

22.5° Mitered Panel

22.5° Mitered Panel



Glass Cut-Out

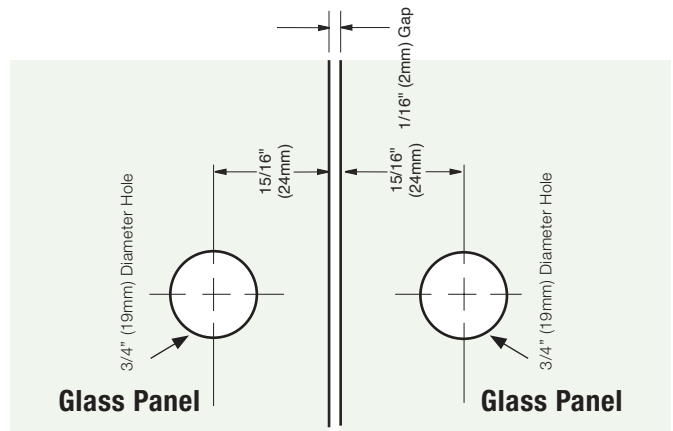

Glass Panel

Glass Panel

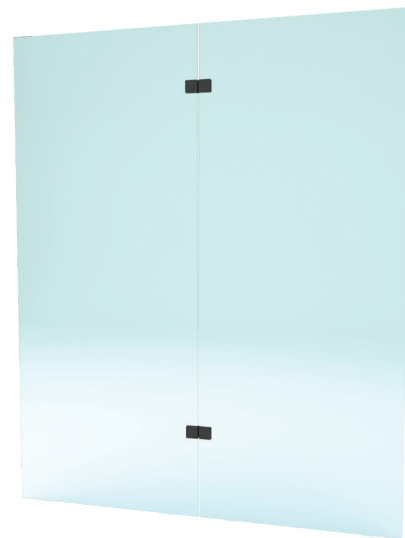

Glass Requirements

- 3/8" (10mm) Tempered Glass
- 1/2" (12mm) Tempered Glass

Specifications

- Solid brass body and clear polyurethane gaskets
- Screws and gaskets included

Cares

- Can be clean with water and a soft cloth
- Use of harsh or abrasive cleaners may harm finish and will void the warranty
- Do not use power tools when installing or spray lubricant on these clamps

NO HOLE CLAMPS

Sleeve Over Glass-to-Glass 90° Clamp

Z-CGC90

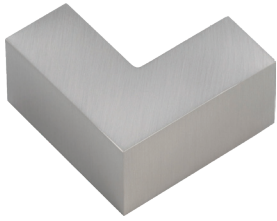

- CP
- BN
- MB
- BG

Sleeve Over Glass-to-Glass Adjustable Clamp

Z-CGCAD002



Adjustable from 90° to 180°

- CP
- BN
- MB



These Clamps are not designed to replace headers or support bars. Clamps are secured in place by set screws on the back

Sleeve Over Left Wall Mount Clamp

Z-SFM005L



Left handed as view from outside the shower

- CP
- BN
- MB

Sleeve Over Right Wall Mount Clamp

Z-SFM005R



Right handed as view from outside the shower

- CP
- BN
- MB



*Example of left Sleeve Over

These Clamps are not designed to replace headers or support bars. Clamps are secured in place by set screws on the back

Rounded Shelf Clamp

Z-SC12



Max 5" Glass Protution from wall is recommended, unless used in a corner shelf.

- CP
- BN
- MB
- BG

Corner Shelf Glass

T-SH10X10

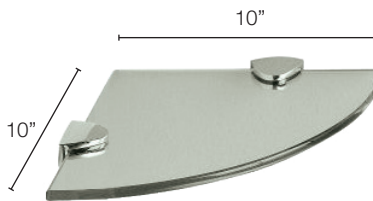

Tempered Safety Glass. Clamps not included.

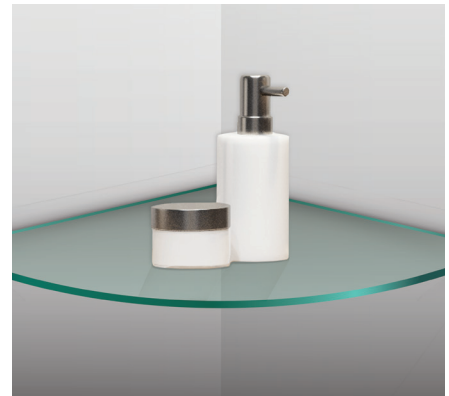

Specifications

- Material: Solid Brass
- No holes required on Glass

Glass Requirements

- 3/8" (10mm) Tempered Glass
- 3/8" (10.38mm) Laminated Glass
- 1/2" (12mm) Tempered Glass

U-Channel 95" For 3/8" (10mm) Glass

Z-U10A



U-Channel 144" For 3/8" (10mm) Glass



Z-U10B



U-Channel 144" For 1/2" (12mm) Glass



Z-U12A

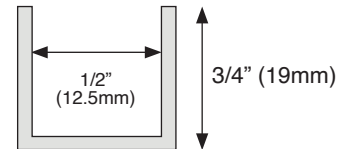
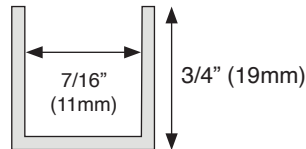

Glass Requirements

- 3/8" (10mm) Tempered Glass
- 3/8" (10.38mm) Laminated Glass

Glass Requirements

- 1/2" (12mm) Tempered Glass

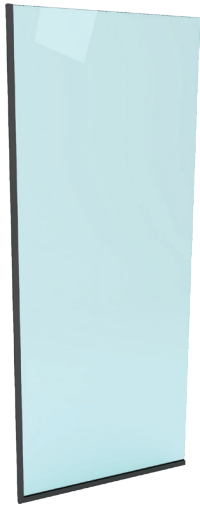

Specifications

- Material: Aluminium
- No holes required on Glass
- No pre-drilled holes in channel

Cares

- Can be clean with water and a soft cloth
- The use of harsh or abrasive cleaners may harm finish and will void the warranty



Wall-to-Glass Support Bar

Z-5431B



Material: Tubular Brass
No holes required on glass.
Stock bar length: 51"

Fixed panel support bar will stabilize glass that do not go all the way to the ceiling. Cut to size required.

Glass Requirements

- 3/8" (10mm) Tempered Glass
- 3/8" (10.38mm) Laminated Glass
- 1/2" (12mm) Tempered Glass

Shower Door Header Kit 98"

Z-SDH001A

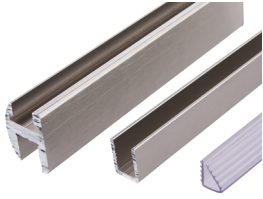

- CP
- BN
- MB
- BG

Kit Includes

- Header 98" or 144" in length
- Snap-In Filler for Door Pocket 36"
- Gasket for 3/8" (10mm) Glass

Glass Requirements

- 3/8" (10mm) Tempered Glass
- 3/8" (10.38mm) Laminated Glass
- 1/2" (12mm) Tempered Glass

Cares

- Can be clean with water and a soft cloth
- The use of harsh or abrasive cleaners may harm finish and will void the warranty

Shower Door Header Kit 144"

Z-SDH001B

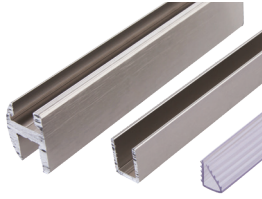

- CP
- BN
- MB
- BG

Will provide additional support and a level of safety while securing glass panels not reaching the ceiling. Highly recommended on Neo-Angle installations.

Specifications

- Material: Aluminum
- No holes required in Glass
- For 1/2" glass do not use vinyl gasket

Not Included in Kit

- Wall Brackets (Z-BW2)

Wall Mounting Brackets

Z-BWB2



For use with header. Sold in pairs. Includes: Mounting screw. Material: Solid Brass.

Adjustable Header Corner

Z-BHC373



For use with header when a corner is needed. Includes: Mounting screw. Material: Solid Brass.



Standard Adaptor Block

Z-HAB01



- CP
- BN
- MB
- BG

Allows Standard Pivot Hinge (Z-3830 or Z-3820) to be mounted into header. Includes: Mounting screw. Material: Solid Brass.

Neo-Angle Shower Enclosure Example



Inline 180° Side Seal Soft Leg For 3/8"

PS10

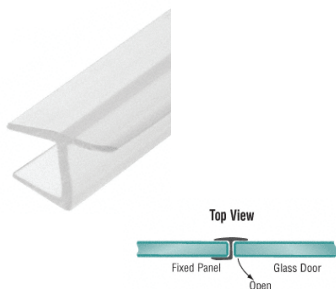

Snaps into Fixed Panel
Material: Polycarbonate
Stock Length: 98"
Glass Thickness: 3/8" (10mm)
Suggested Gap: 3/16" (5mm)

Inline 180° Side Seal Soft Leg for 1/2"

PS12

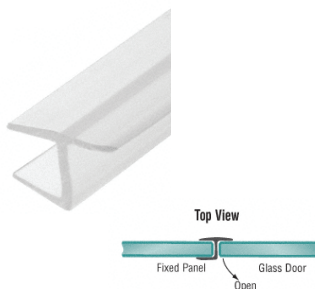

Snaps into Fixed Panel
Material: Polycarbonate
Stock Length: 98"
Glass Thickness: 1/2" (12mm)
Suggested Gap: 3/16" (5mm)

CRL Inline 180° Side Seal Hard Leg For 3/8"

P380HJ

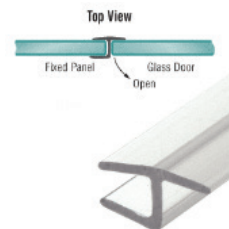

Snaps into a fixed panel
Material: Polycarbonate
Stock Length: 95"
Glass Thickness: 3/8" (10mm)
Suggested Gap: 3/16" (5mm)

Bottom Wipe With Drip Rail For 3/8"

PB10

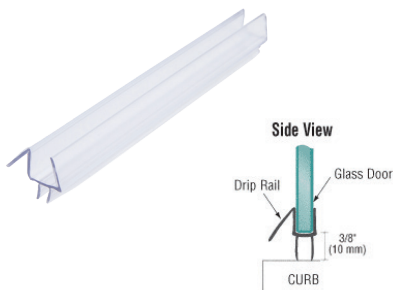

Snaps into bottom of door
Material: Polycarbonate
Stock Length: 98"
Glass Thickness: 3/8" (10mm)
Suggested Gap: 3/8" (10mm)

Bottom Wipe With Drip Rail For 1/2"

PB12

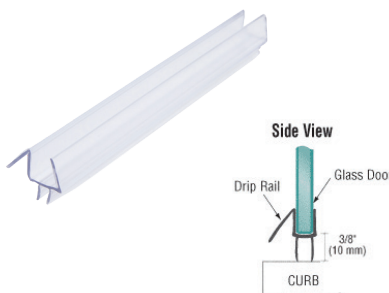

Snaps into bottom of door
Material: Polycarbonate
Stock Length: 98"
Glass Thickness: 1/2" (12mm)
Suggested Gap: 3/8" (10mm)

CRL 90° Finseal For 3/8"

PC1090

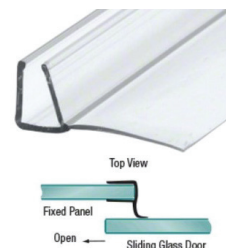

Ideal for use with sliding systems
Material: Polycarbonate
Stock Length: 95"
Glass Thickness: 3/8" (10mm)
Suggested Gap: 13/16" (20mm)

Bulb Seal For 3/8"

PR10

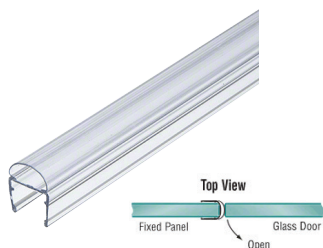

Snaps into a fixed panel or door
Material: Polycarbonate
Stock Length: 98"
Glass Thickness: 3/8" (10mm)
Suggested Gap: 1/4" (6mm)

Bulb Seal for 1/2

PR12

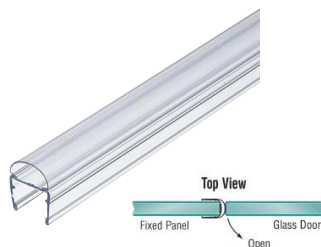

Allows doors to swing both in and out of the enclosure if desired.
Material: Polycarbonate
Stock Length: 98"
Glass Thickness: 1/2" (12mm)
Suggested Gap: 1/4" (6mm)

CRL Threshold

SDT980CLR

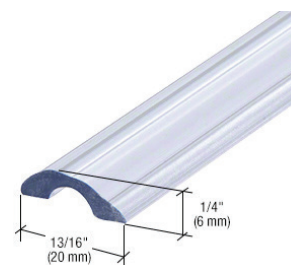

Pack of 5 Pcs
Type Use: Installed as a threshold in shower stalls to assist watershed back into the stall. Soft contour won't harm bare feet.
Material: Polycarbonate
Stock Length: 95"



SLIDING SHOWER DOORS

Century Sliding 180° Shower Door Kit



The Century System is a very traditional sliding system which brings an elegant fully frameless shower enclosure. The hardware is made of Aluminium and both doors slide sideways.

Item #	Max Width	Height	Towel Bar	Type	Glass Included
V-10D6460	60"	64"	24"	Tub	Yes
V-10D7260	60"	72"	24"	Shower	Yes
V-10D7660	60"	76"	24"	Shower	Yes
Y-KD8072	72"	84"	24"	Custom	No

Available Finishes



Care and Cleaning

- Use only mild detergent or warm soapy water applied with soft cloth for regular cleaning
- Always rinse well after cleaning and dry by blotting with a damp cloth
- The use of scouring pads gritty cloth and harsh abrasive cleaners should always be avoided

Glass Included

- 3/8" Tempered Glass

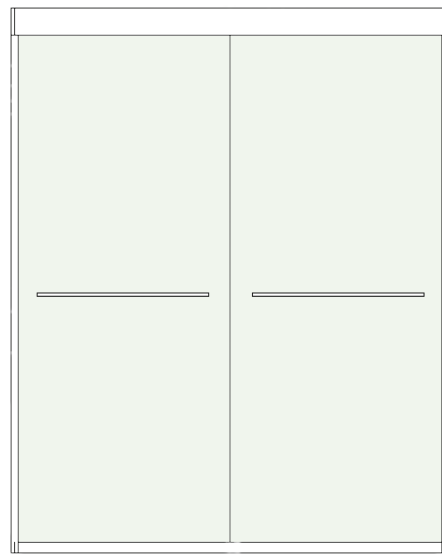

Included

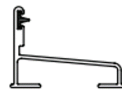

(1) Bottom Sill



(1) Header

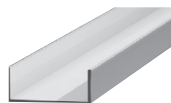

(2) Side Jamb

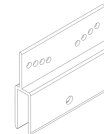

(4) Top Hangers with wheels

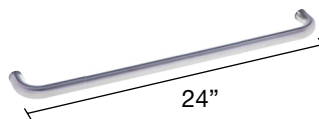

(2) Towel Bars

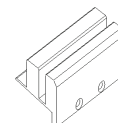

(1) Floor Guide



Denali Series Frameless Sliding Shower Door Kit



Our popular Denali Series Frameless Sliding Shower Door Kit offers a modern, low profile design, that includes a rectangular header and round glass rollers. It's engineered for use with 3/8" (10mm) tempered glazing. Each top glass roller requires one 5/8" (16mm) diameter hole in the glass for proper mounting. Precision bearings and wheels also offer a quiet glide experience. One standard size fits most 180 degree inline applications. Our in stock 78" wide kits can be cut to size.

NOTE: Fixed glass panel hardware like u-channels or clamps are sold separately.

Available Finishes



Glass Requirements

- 3/8" Tempered Glass

Specifications

- Material: Header Track and Hardware, (304 Stainless Steel)
- Glass Thickness: 5/16" to 3/8" (8 to 10mm) (Glass is not Included)
- Glass Fabrication: Each Included Glass Roller requires one 5/8" Diameter Hole; Each Included Fixed Panel Standoff Fitting requires one 1/2" Diameter Hole;
- Maximum Recommended Slider Weight: 90 lbs

Supplied With



(1) Multiway Door Guide



(2) Fixed Panel Standoff Fittings



(4) Glass Rollers



(1) Sliding Panel Stopper



(2) Wall Mount Fittings



(1) Finger Pull



(1) Jamb L-Seal



(2) WALL Mounting Screws and Anchors



(1) Header Track

Denali Series Frameless Sliding Shower Door Kit

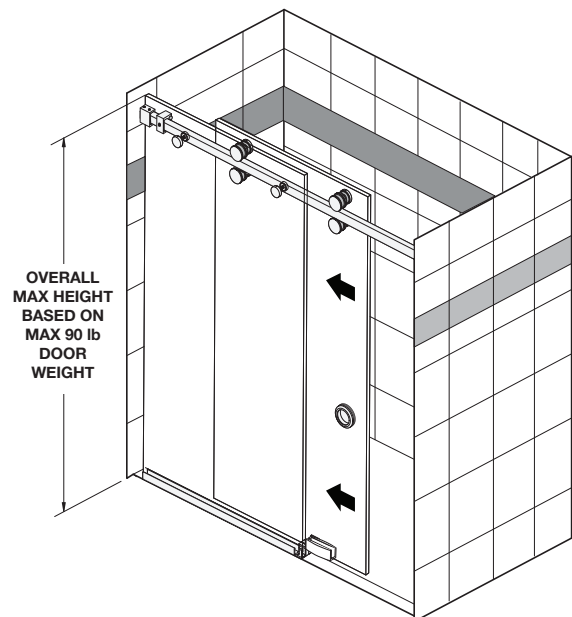
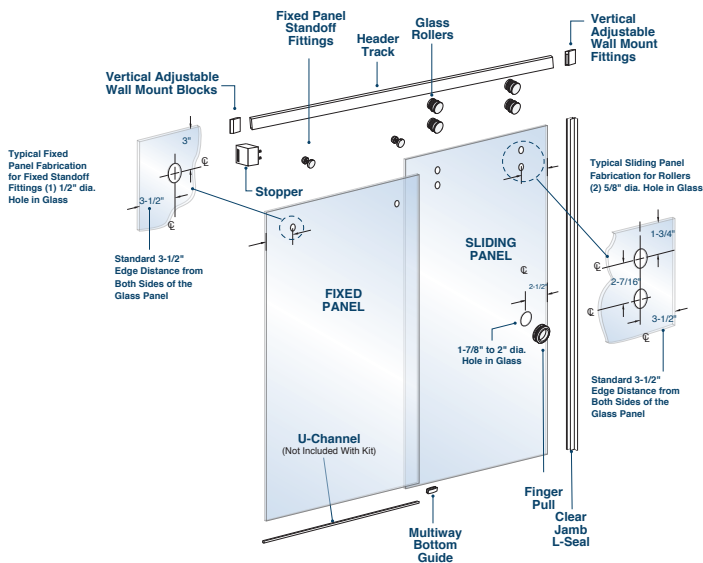
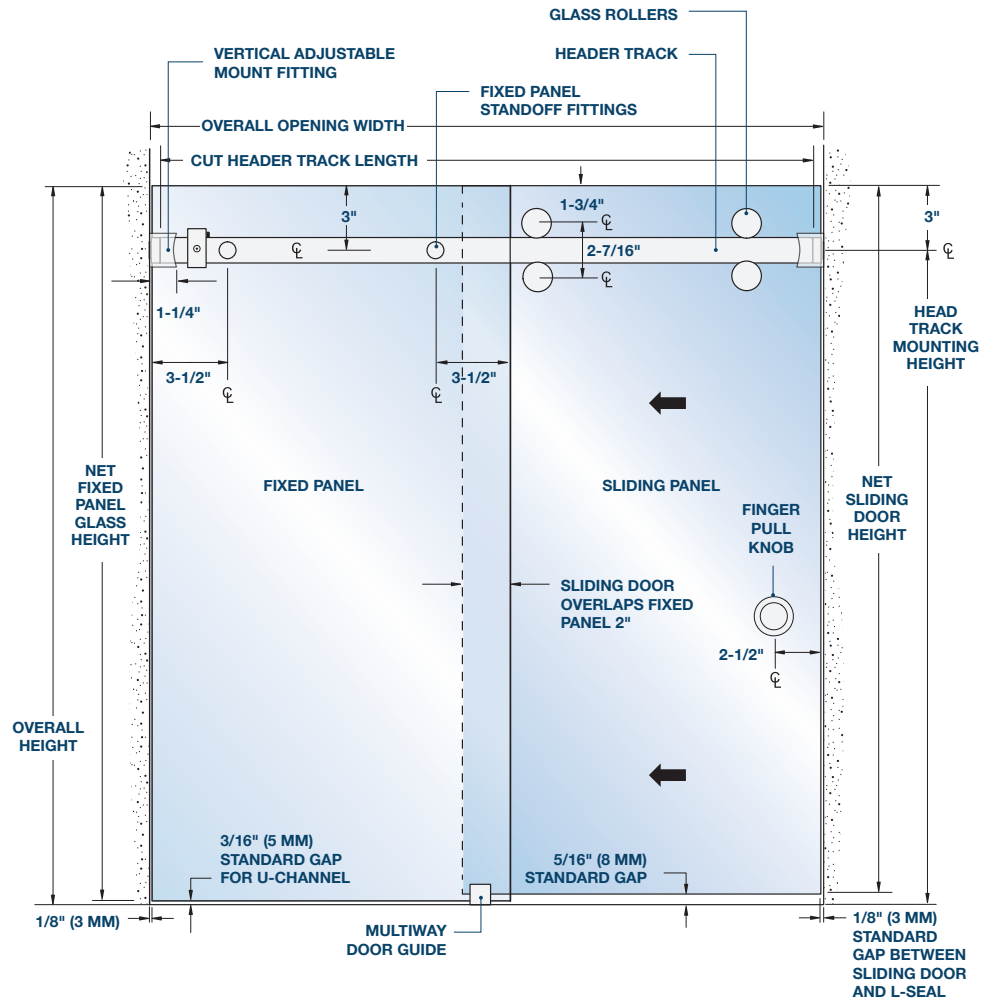

Clearwater Series Frameless Sliding Shower Door Kit



Our popular CLEARWATER Series Frameless Sliding Shower Door Kit offers a modern, low profile design, that includes a round header bar and round glass rollers. It's engineered for use with 3/8" (10mm) or 1/2" (12mm) tempered glazing. Each top glass roller requires one 5/8" (16mm) diameter hole in the glass for proper mounting. Precision bearings and wheels also offer a quiet glide experience.

One standard size fits most 180 degree inline applications. Our stock 78" wide kits can be cut to size.

NOTE: Fixed glass panel hardware including u-channels, and clamps are sold separately. Pull sold separately.

Available Finishes



Glass Requirements

- 3/8" Tempered Glass

Specifications

- Material: Header Track and Hardware (304 Stainless Steel)
- Glass Thickness: 3/8" or 1/2" (10 or 12 mm) (Glass is not Included)
- Glass Fabrication: Each Included Glass Roller requires one 5/8" Diameter Hole; Each included Fixed Panel Standoff Fitting requires one 5/8" Diameter Hole;
- Maximum Recommended Slider Weight: 100 lbs

Supplied With



(1) Header Track



(2) Wall Mount Fitting



(4) Glass Rollers



(1) Bottom Guide



(1) Sliding Panel Stopper



(2) Fixed Panel Fitting



(1 of each) Bottom Sweep with Drip Rail



(1) Jamb L-Seal

Clearwater Series Frameless Sliding Shower Door Kit

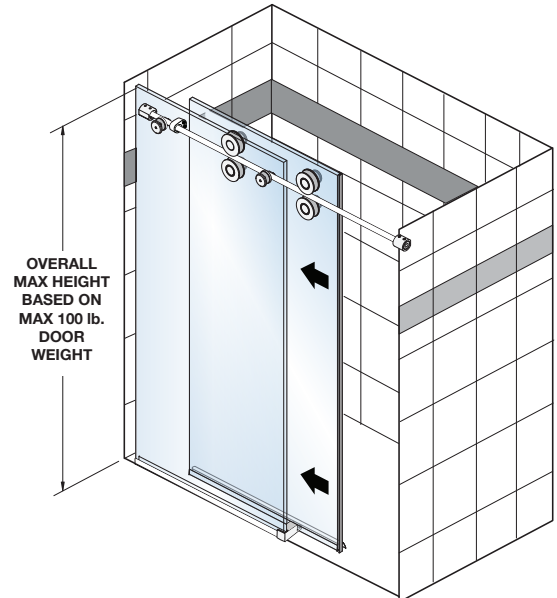
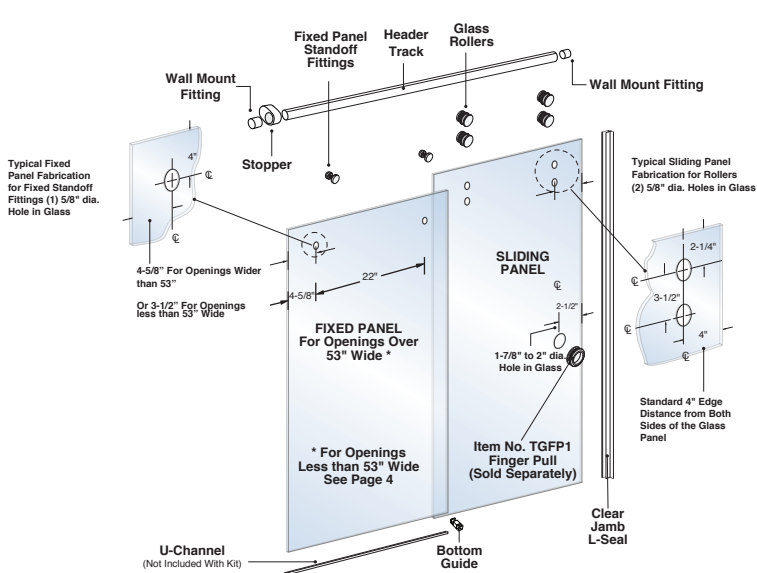
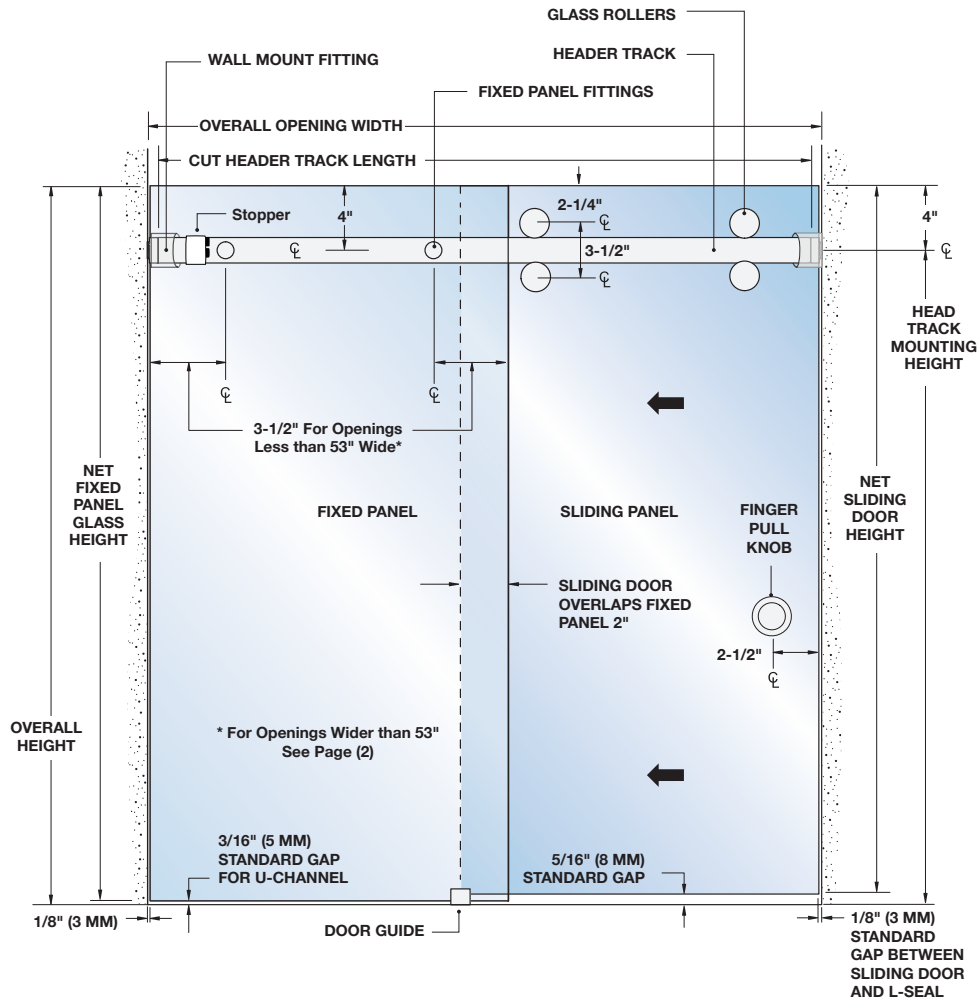

Napa Series Frameless Sliding Shower Door Kit



Our Popular Napa Series Frameless Sliding Shower Door Kits offer a low-profile header track and glass rollers that are designed and manufactured from heavy-duty durable stainless-steel. Each glass roller requires one 3/4" (19mm) diameter hole for proper mounting. Precision bearings and stainless-steel wheels also offer a quiet glide opening and closing operation. Another nice feature, this system can be installed in a wide range of shower applications from full standing shower enclosures or on top of bath tubs.

One standard size fit's most 180-degree bypass inline applications. Stock Available Size: 73" Wide Kit

Available Finishes



Glass Requirements

- 3/8" Tempered Glass

Specifications

- Material: Header Track and Hardware, (Stainless Steel)
- Glass Thickness: 3/8" (10mm) (Glass is not Included)
- Glass Fabrication: Each Included Glass Roller requires one 3/4" Diameter Hole; Two 1/2" Diameter Holes are required for Each Towel Bar
- Maximum Recommended Slider Weight: 90 lbs

Supplied With



(1) Header Track



(8) Glass Rollers



(2) Wall Mount Fitting

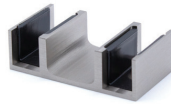

(1) Bottom Guide



(2) Sliding Panel Stopper



(2) Bottom Sweep with Drip Rail



(2) Jamb L-Seal



(1) Tool Kit/Anchors



(2) 24" (610 mm) Single Sided Towel Bars

Napa Series Frameless Sliding Shower Door Kit

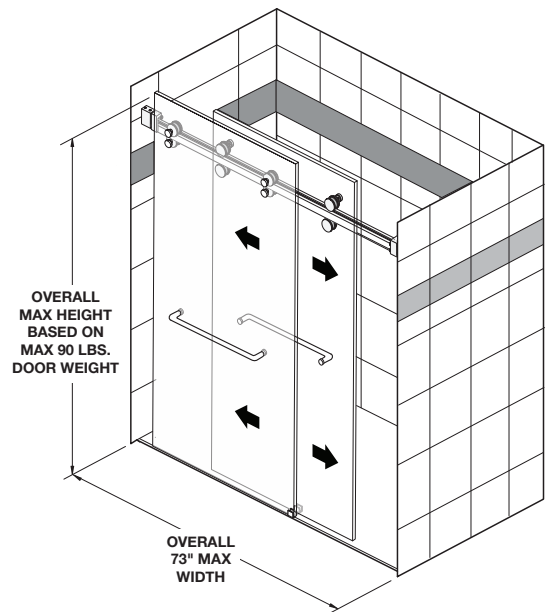
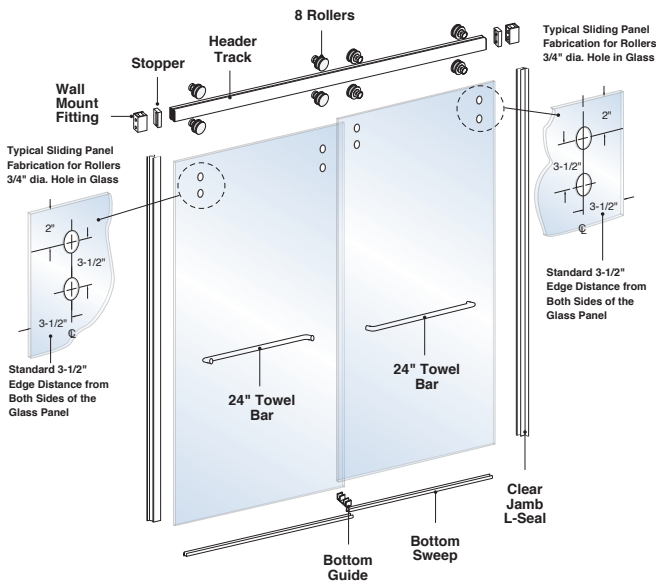
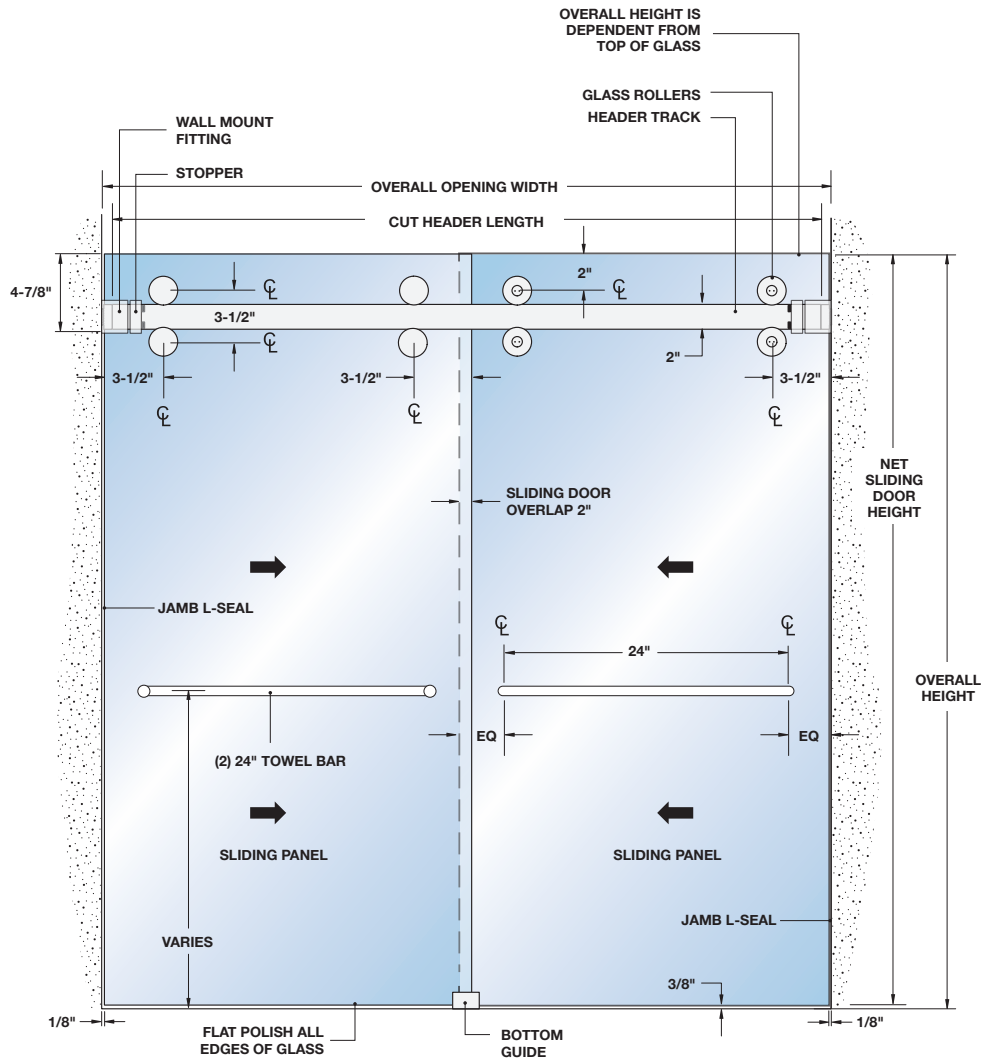



GLASS RAILINGS

Garda Base Shoe System



Thanks to the use of frameless glass, these balustrades guarantee the highest level of clean lines in new construction, renovation and restoration projects: they are available with or without caprails. The system is designed to guarantee an easy and rapid assembly and an aesthetic result ideal for the world of contemporary architecture.



Available Finishes



Glass Required

- 1/2" (12 mm) Tempered Glass
- 9/16" (13.52 mm) Laminated Tempered Glass
(1/4" + 0.060" SGP + 3/8") / 6.6.4
- 13/16" (21.52 mm) Laminated Tempered Glass
(3/8" + 0.060" SGP + 5/16") / 10.10.4

Parts Sold Individually

- See parts available in page 36



Surface Mount



Recessed Mount



BASE SHOE RAILING

Pre-Drilled Base Shoe

RBS120D

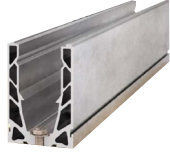

Material: Aluminum
Length: 236" (6m)
48 Pre-drilled holes of 1/2" (12.5 mm)

Pre-Drilled Lateral Shoe

RLS240D

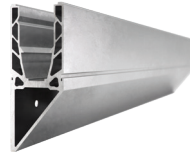

Material: Aluminum
Length: 236" (6m)
48 Pre-drilled holes of 1/2" (12.5 mm)

Adjustable Clamp



Glass Thickness	Code
1/2" (12mm)	RZ06
9/16" (6.6.4)	
13/16" (10.10.4)	RZ10

Base Shoe Top Cladding 118" (3m)

RTC10

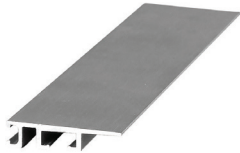

Material: Aluminum
Length: 118" (3m)

Base Shoe Cladding 118" (3m)

RC10



Material: Aluminum
Length: 118" (3m)

Lateral Shoe Bottom Cladding 118" (3m)

RBC10



Material: Aluminum
Length: 118" (3m)

Glazing Gasket for Cladding 100'



Glass Thickness	Code
1/2" (12 mm)	RG06X100BL
9/16" (6.6.4)	
13/16" (10.10.4)	RG10X100BL

Screw-Bolt+ Anchor

PFM1411300



Material: Zinc
Substrate: Concrete
Size: 3/8" x 5"

Drain Block

BSDB38

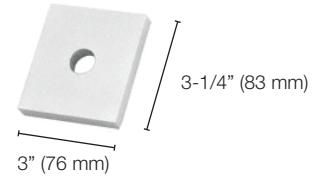

Material: Aluminum
Thickness: 3/8" (10mm)

Gasket Gap Filler Strip

RGV1



Length: 12"
Fills gap between 2 pieces of glass

Mini Cap Rail

RCU120



Material: Aluminum
Length: 118" (3m)
Glass Require: 13/16" (10.10.4) only
Use double face tape to mount on glass

Base Shoe End Cap

REC1

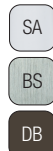

Material: Aluminum
Includes: Mounting screw

Round End Cap

REC2



Material: Aluminum
Includes: Mounting screw

Glazing Gasket for Round Cap Rail 100'



Glass Thickness	Code
1/2" (12mm)	RG06
9/16" (6.6.4)	
13/16" (10.10.4)	RG10

Round 1.9" Cap Rail

RCR120



Material: Aluminum
Length: 236" (6m)
Require: Glazing Gasket (RG06 or RG10)

Installation Steps

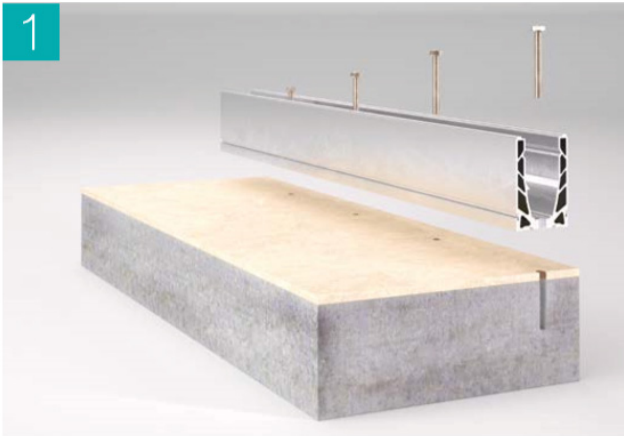

Drill the slab, position the profile and fix the screws.



Lay the clamps inside the profile every 10". Do not place the clamps on top of the anchor screw.

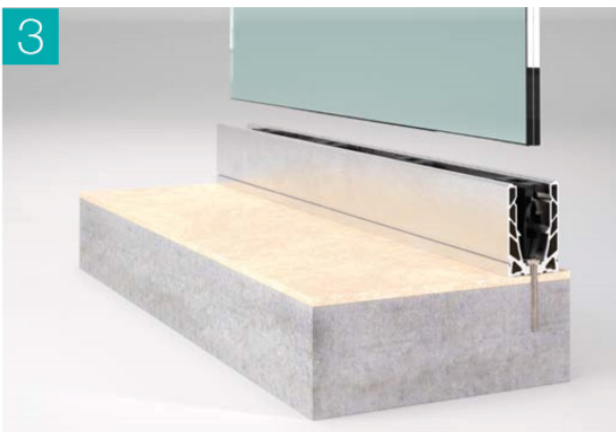

Insert the glass.



Adjust the inclination of the glass using the screws on the clamps with a 5/32" (4 mm) hex driver and tighten.



Snap the cladding in place, to which the seal has been previously inserted.

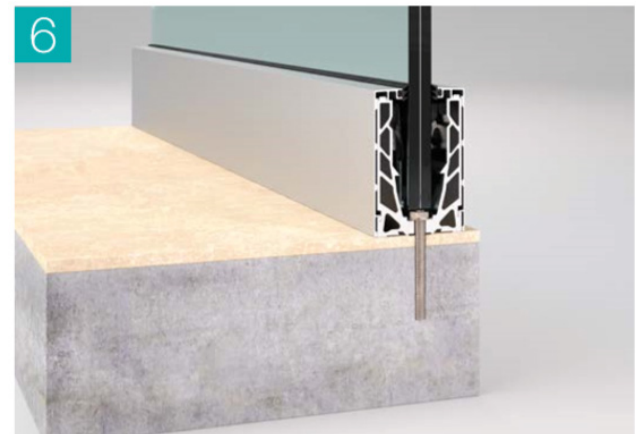

Installation Finished.

RAILING STANDOFFS

Standoff 2"

Z-RB2134

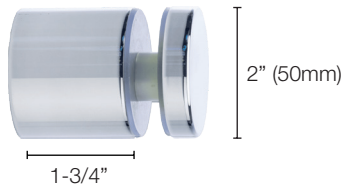

PS

BS

MB

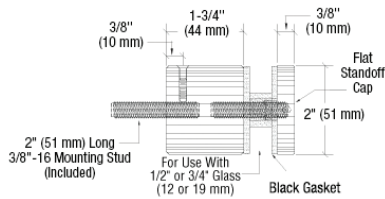

Glass Requirements

- 1/2" (12mm) Tempered Glass
- 9/16" (13.52mm) Laminated Tempered Glass
- 3/4" (19mm) Tempered Glass

Specifications

- Includes: - Socket screw for Metal Substrate
- Hanger bolt for Wood Substrate
- Material: Solid Stainless Steel 316
- Glass Fabrication: One 3/4" (19mm) Diameter Hole

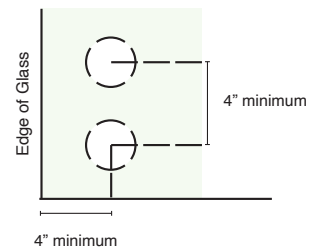

Cares

- Can be cleaned with water and a soft cloth
- Use of harsh or abrasive cleaners may harm finish and will void the warranty

Standoff 1-1/2"

E004720163

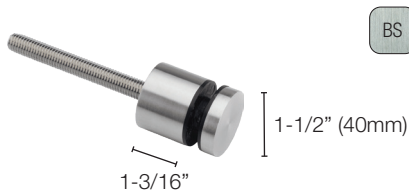

Standoff Cap Wrench 2"

E4079650



Use to tight the cap without damaging the Standoff

Standoff Cap Wrench 1-1/2"

E4079640

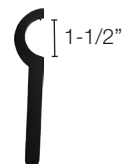

Use to tight the cap without damaging the Standoff



Hand Rail Tube

E0016000



Material: 316 Stainless Steel
Diameter: 1-11/16" (42mm)
Stock Length: 236" (6m)

Hand Rail Cap

E4100



Designed for Hand Rail Tubing 1-11/16"(42mm)

Hand Rail Wall Support

E0223



Designed for Hand Rail Tubing 1-11/16" (42mm)

Adjustable Hand Rail Glass Support

E004720172

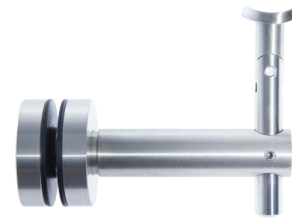

Designed for Hand Rail Tubing 1-11/16"(42mm)
To be used in 1/2" glass to 1-1/16" (25mm) glass
Hole Diameter Required: 3/4" (19mm)

Adjustable Strap Wrench

ASW12



Tool used for tightening cap and barrel in standoffs without damaging finish.
Adjustable from 3/4" to 4" diameter.

Standoff for Wall/Countertop 1"

Z-S025BS

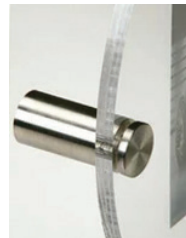

Glass Requirements

- 3/16" (5mm) Tempered Glass
- 1/4" (6mm) Tempered Glass
- 3/8" (10mm) Tempered Glass

Specifications

- Not for outdoor use
- Does not include anchor screw
- Material: Solid Stainless Steel 304
- Glass Fabrication: One 1/2" (12mm) Hole

Cares

- Can be cleaned with water and a soft cloth
- Use of harsh or abrasive cleaners may harm finish and will void the warranty



OFFICE PARTITIONS

All Glass Office/Storefront



Available Finishes



Specifications

- Material: Stainless Steel 304
- Maximum Door Height: 102" (2590mm)
- Maximum Door Width: 39" (1000mm)
- Maximum Door Weight: 220 lbs (100kg)
- Open angle: 140°
- Door hold open: 90°
- Pivot Point: 2-9/16" (65mm)

This system is an excellent option for Storefronts and Office enclosures. Requires no cutting or digging the floor, nor an overhead header. Achieve an all glass partition with the minimal hardware.

Parts Sold Individually

- See parts available in page 42 and 43

Cares

- Can be cleaned with water and a soft cloth
- Use of harsh or abrasive cleaners may harm finish and will void the warranty
- Do not use power tools when installing or spray lubricant on this hinges



COMMERCIAL PIVOT DOOR PARTS

Commercial Tubular Handle 12"

Z-CP12X12

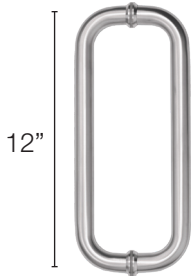

12"

Material: 1-1/4" (32mm) Tubular Stainless Steel 304
Hole Diameter Required: 5/8" (15mm)

Commercial Ladder Handle 24"

Z-LP24

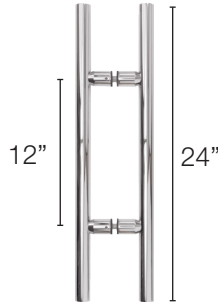

12"

24"

Commercial Ladder Handle 36"

Z-LP36

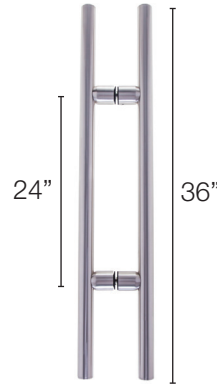

24"

36"

Locking Ladder Handle 48"

CML48

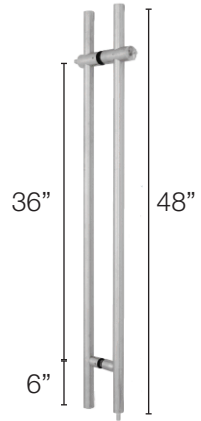

36"

48"

Includes key set and dust proof keeper
Top Hole: 1-1/4" (32mm)
Bottom Hole: 5/8" (16mm)

Hydraulic Patch Door Kit

PF2090



Top Patch Cut-Out

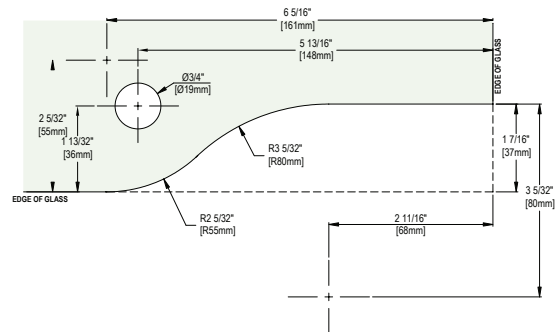

Glass Requirements

- 3/8" (10 mm) Tempered Glass
- 1/2" (12 mm) Tempered Glass

Kit Includes

- Hydraulic Bottom Patch Fitting (380H)
- Top Patch Fitting (EUR201)
- Top Centre-Hung Free Swing Pivot (1NT401)
- Top Patch Insert (1NT303)

Bottom Patch Cut-Out

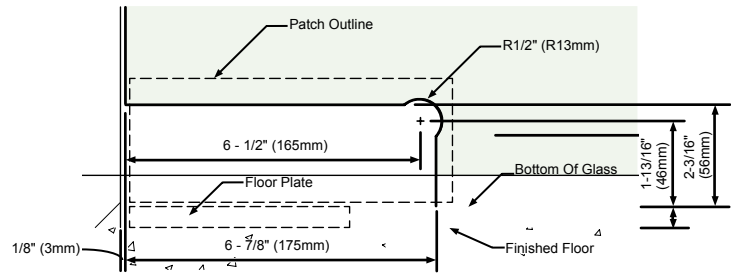

Patch Door Lock

PF205CT



Can be mounted at the bottom of the door or on the side.
Includes key set and keeper.

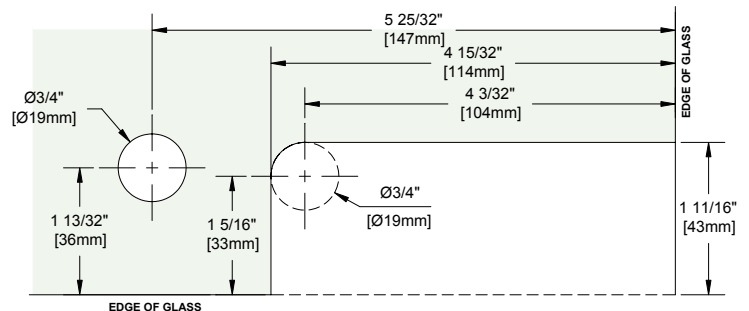

COMMERCIAL FIXED PANEL PARTS

Commercial U-Channel 1"

UC10X120

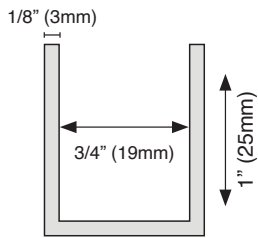

Material: Aluminum
Length: 120"

Commercial U-Channel 1-1/2"

UC15X120

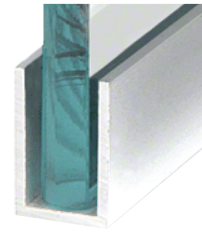
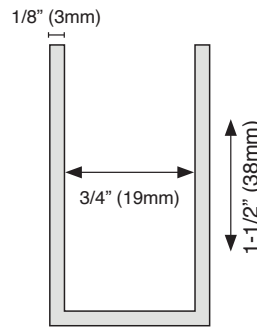

Glass Requirements

- 3/8" (10mm) Tempered Glass
- 3/8" (10.38mm) Laminated Glass
- 1/2" (12mm) Tempered Glass
- 1/2" (12.76mm) Laminated Glass
- 3/4" (19mm) Tempered Glass

End Cap For U-Channel 1"

UC10EC

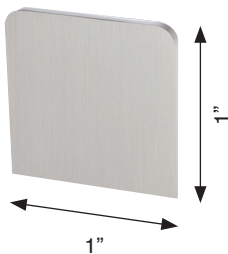

Material: Aluminum

End Cap For U-Channel 1-1/2"

UC15EC

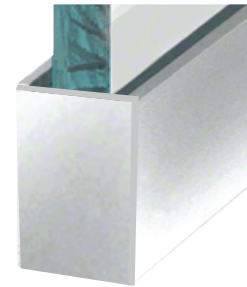
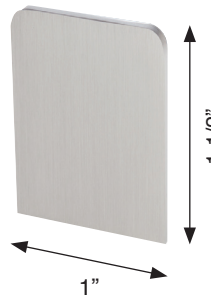

Roll-in Glazing Gasket RG38100

RG38100

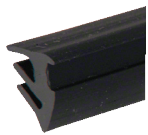

Dry glaze installation for 3/8" Glass
Length: 100"
Material: Vinyl
Color: Black

Roll-in Glazing Gasket RG12100

RG12100

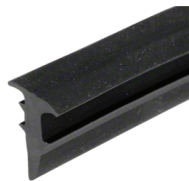

Dry glaze installation for 1/2" Glass
Length: 100"
Material: Vinyl
Color: Black

Gasket Roller Tool VR10

VR10



Snaps glazing gasket into u-channel

Neoprene Setting Block SB565

SB565



For use inside commercial u-channel
Dimensions: 1/2" x 1/2" x 2"
Material: Neoprene

Extra Heavy-Duty Wall Mount Bracket Z-3100

Z-3100



Material: Solid Brass

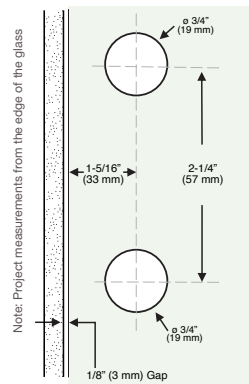

Glass Requirements

- 3/8" (10mm) Tempered Glass
- 1/2" (12mm) Tempered Glass
- 9/16" (13.52mm) Laminated Tempered

BARN DOORS SYSTEM

Lacrosse Barn Door Kit

LAK96

Lacrosse
Barn Style Sliding Doors



The Lacrosse Series Wall Mount Single Slider Kit contains all the components you will need (except the glass) to complete this style of installation. This model is used in applications where you are attaching a single sliding door to the inside face of a sufficiently reinforced wall. Suitable for offices, closets, storefronts or other commercial entrances.

Supplied With



(2) Track Rollers

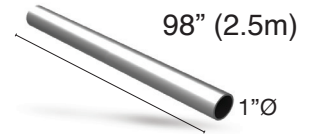

(1) Tube



(2) Track Holder Fitting



(1) Bottom Guide



(2) Stoppers



(2) End Caps

Available Finishes



Features

- Material: Stainless Steel 316
- Application: Single Glass Door
- Installation: Surface mounted
- Max Door Weight: 200 lbs (90Kg)
- Max Door Width: 48" (1200mm)

Glass Required

- 3/8" (10mm) Tempered Glass
- 1/2" (12mm) Tempered Glass
- 9/16" (13.52mm) Tempered Laminated Glass

Not Included

- Tempered Glass
- Handle

Fabrication Instructions

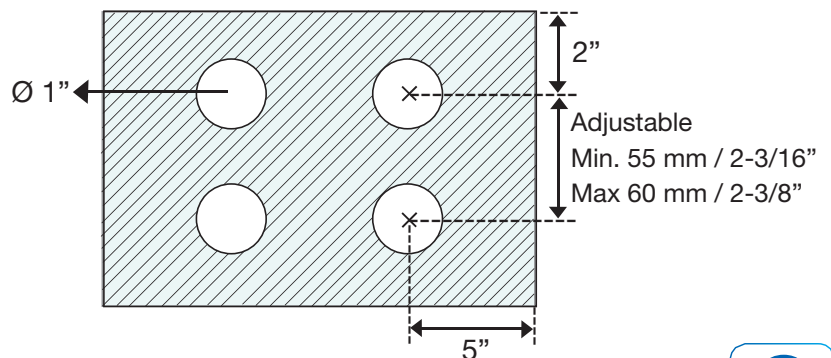

Metal Fabrication

Holes on the track should be made during installation.



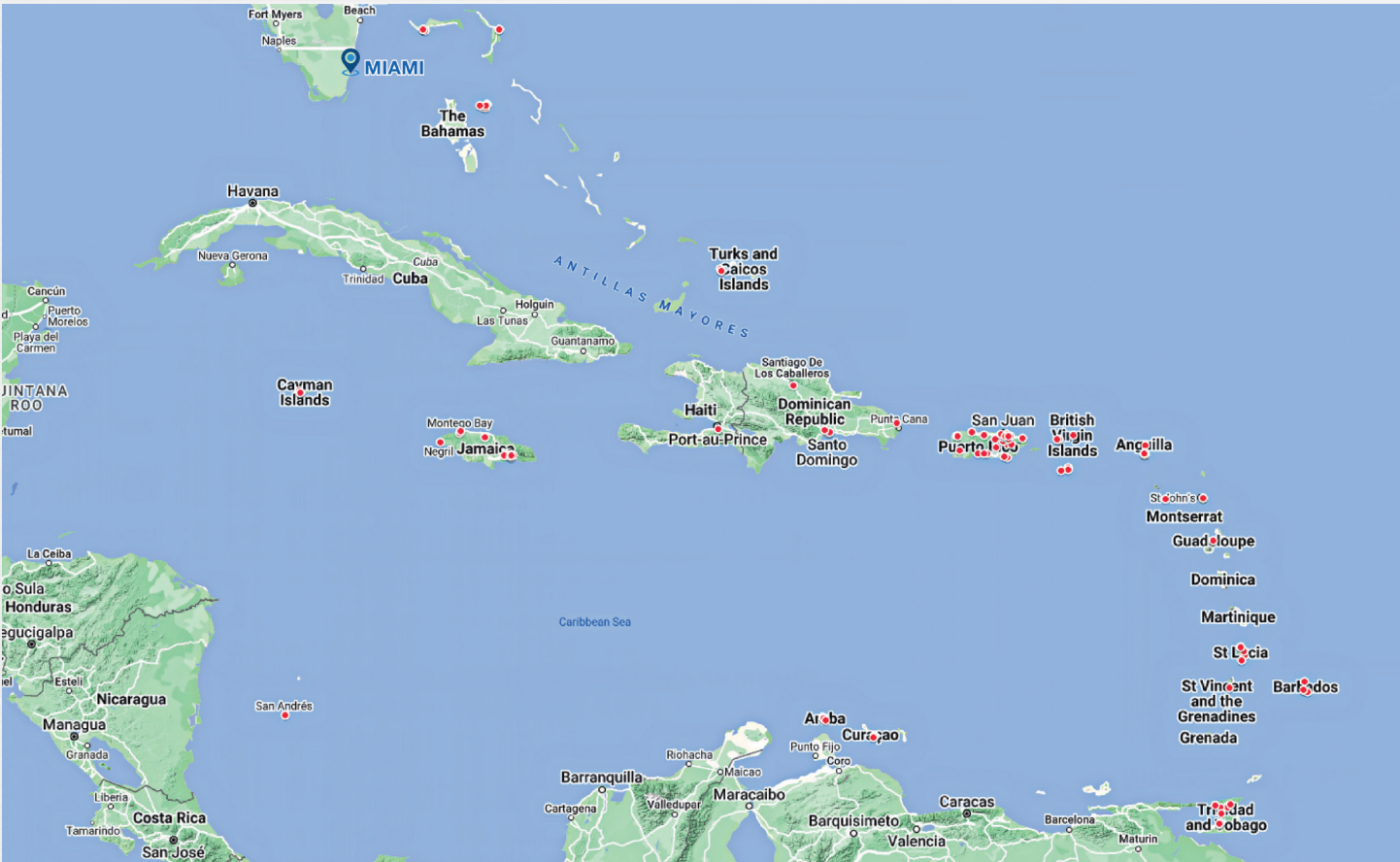

WE EXPORT

Focused on the Caribbean, Interglass is able to satisfy all the glass or mirror needs by delivering small shipments (LCL) to freight forwarders in any of the South Florida ports or deliver direct (Door to Port) full container loads to almost all the islands, as well as Central or South America. We are able to load full 20' containers (close or open top) with combined glass types. We assemble our own custom wood crates with A-Frames in-house; strong enough to protect the glass inside and forklift-friendly so that freight forwarders can consolidate into containers.



Wood Crates with A-Frame Legs Example





(800) 576-6044 | sales@interglassusa.com

 interglasscorp
  interglasscorp
  interglass-corp

www.interglassusa.com

